

PREMIER *PLATINUM* INFRARED METHANE AND CARBON DIOXIDE 'BIOGAS' SENSOR

Non Exd versions

***** Available in EN50271 / SIL1 Certified versions *****



MSH-DS/HC/HCO2/NC



MSH-DP/HC/HCO2/NC

FEATURES

- ★ Combines all the features of the Hydrocarbon and Carbon Dioxide Premier sensors, enabling the measurement of two different gases with one sensor.
- ★ No increase in physical size or power consumption when compared with a single gas Premier sensor. Ideal for portable, battery powered instruments.
- ★ Contains all the necessary optics, electronics and firmware to provide TWO linearised, temperature-compensated measurements: Methane and Carbon dioxide
- ★ Digital output for direct interface to host circuitry.
- ★ The hydrocarbon and carbon dioxide channels can be used to measure methane from 0 to 100% volume.
- ★ Specifically designed for applications with high concentrations of methane and carbon dioxide simultaneously.
- ★ Fast track route for original equipment manufacturers to introduce the latest infrared technology – without any specialist knowledge.
- ★ Internal Flash memory allowing sensor firmware updates via configuration equipment.

Dynamant Limited

Hermitage Lane Industrial Estate • Kings Mill Way • Mansfield • Nottinghamshire • NG18 5ER • UK.

Tel: 44 (0)1623 663636 •

email: sales@dynamant.com • www.dynamant.com

DESCRIPTION

Dynamant infrared sensors operate by using the NDIR principle to monitor the presence of target gas. The sensor contains a long-life tungsten filament infrared light source, an optical cavity into which gas diffuses, temperature compensated pyroelectric infrared detectors, an integral semiconductor temperature sensor and electronics to process the signals from the pyroelectric detector.

The sensor uses a digital output for direct communications with instrument electronics. The digital output is a UART format comprising 8 data bits, 1 stop bit and no parity. Refer to specification for available baud rates.

Patent Protection

The sensor design is protected by the following Patents

Great Britain	GB 2 401 432 & GB 2 403 291
Europe	EP 1544603 & EP 1818667-Pending
France	EP [FR] 1544603
Germany	EP [DE] 1544603
Italy	EP [I] 1544603
Switzerland	EP [CH] 1544603
USA	7, 244, 939
Other World Patents	Pending

Hydrocarbon Response Characteristics

The Premier range of hydrocarbon infrared gas sensors are calibrated to provide an output signal linearised for a specific gas type and concentration during manufacture.

However, the sensor will also respond to a range of other hydrocarbon gases. The following graphs show the relative response of a methane sensor, and a propane sensor, to some of the common hydrocarbons.

These characteristics can be used as a guide to setting-up the associated instrument alarm levels.

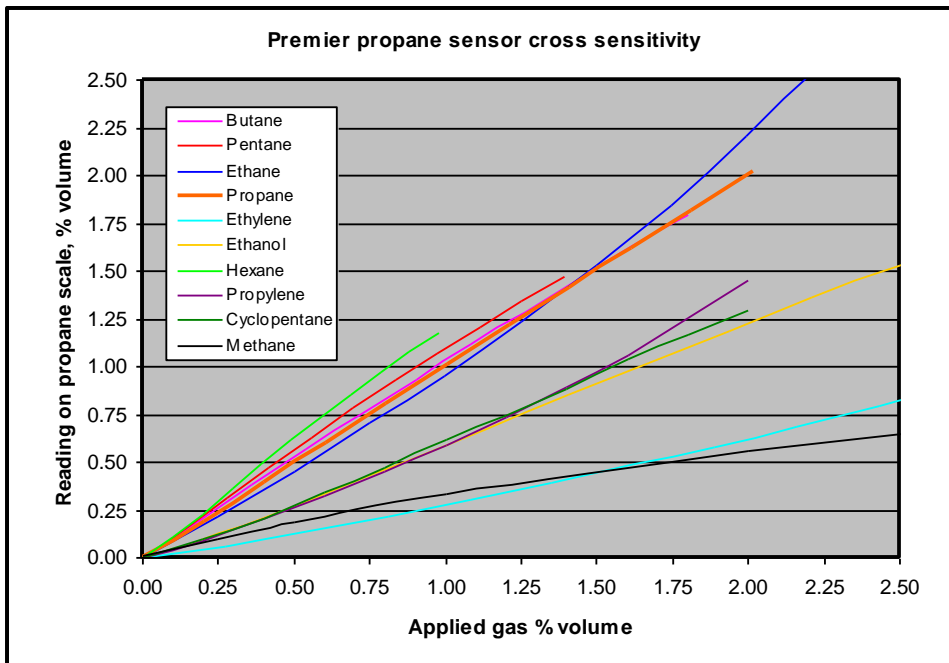
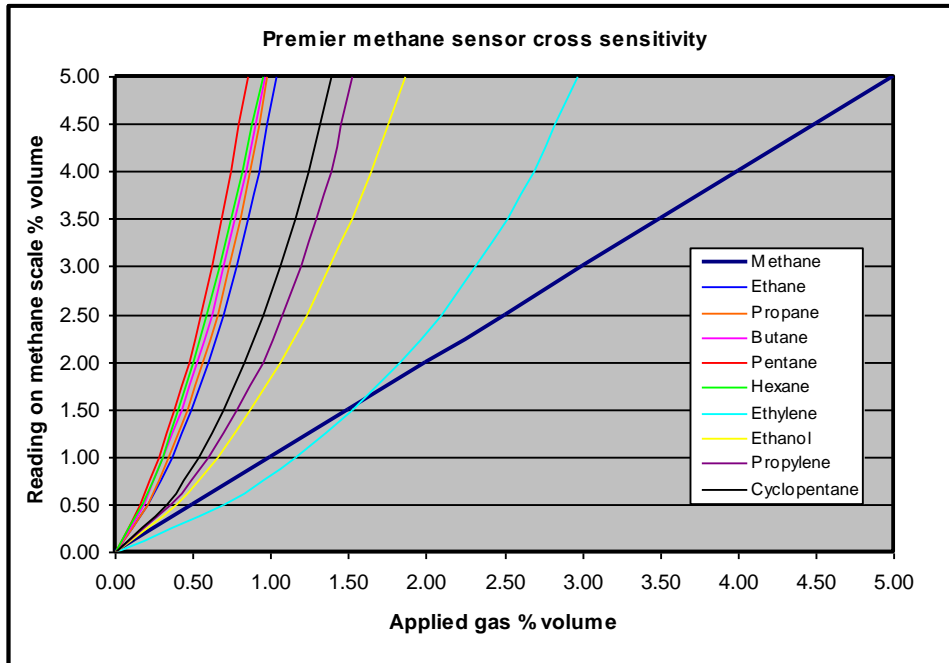

Note – Refer to data sheet TDS0050 for additional cross reference data

Hydrocarbon Temperature Compensation

The Premier sensor is temperature compensated over the range of -20°C to +50°C. The output variation is $\pm 2\%$ FSD or $\pm 10\%$ of the reading up to 50% FSD and $\pm 15\%$ of the reading from 50% to 100% FSD, whichever is greater.

The following graph is based on the hydrocarbon sensor being characterised for methane.

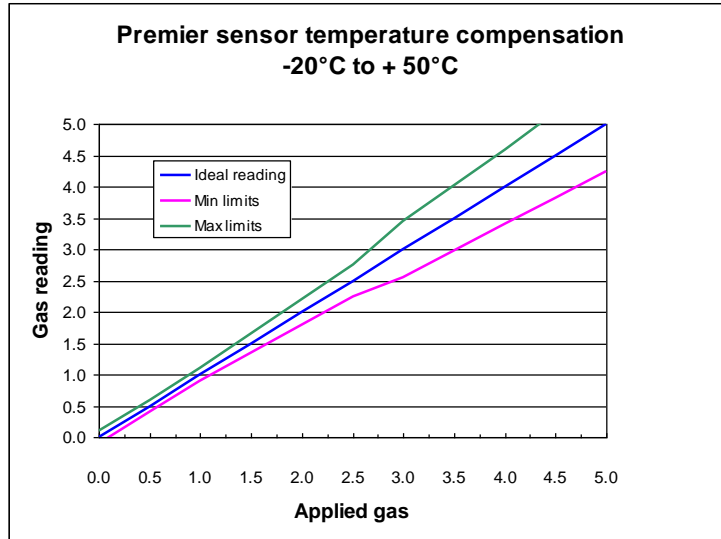

Hydrocarbon Linearity

The Premier sensor linearity at ambient temperature is $\pm 10\%$ of the applied gas, or $\pm 0.05\%$ volume, whichever is greater.

The following graph is based on the hydrocarbon sensor being characterised for methane, data based on 24 sensors.

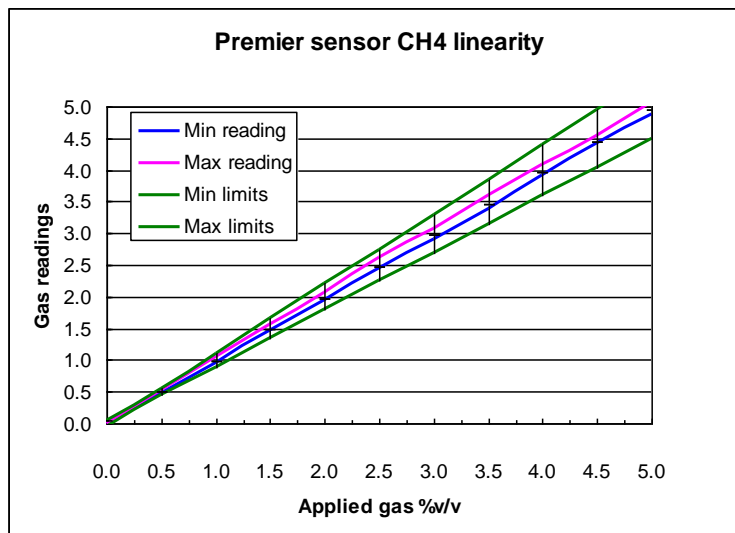

Carbon dioxide Temperature Compensation

The Premier sensor is temperature compensated over the range of -20°C to +50°C. The output variation is $\pm 0.1\%$ v/v or $\pm 10\%$ of the applied gas up to 50% FSD and $\pm 15\%$ of the applied gas from 50% to 100% FSD, whichever is greater.

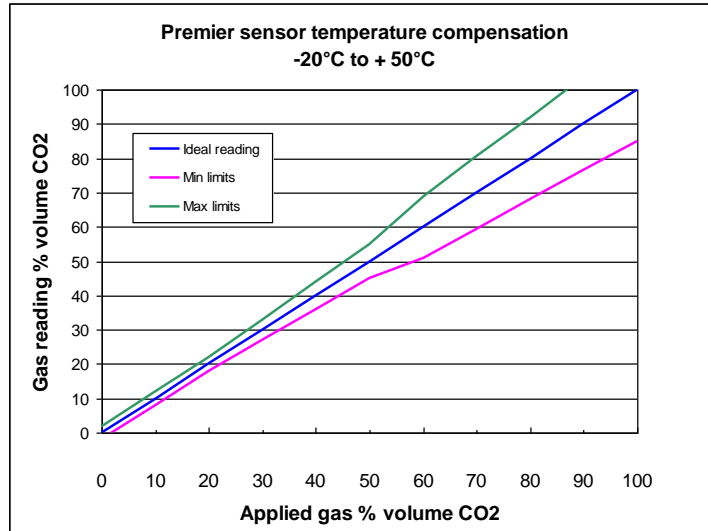

Carbon dioxide Linearity

The Premier sensor linearity at ambient temperature is $\pm 3\%$ full scale or $\pm 10\%$ of the applied gas up to 80% full scale and $\pm 15\%$ of the applied gas from 80% to 100% full scale, whichever is greater.

The following graph is based on the 0-100% v/v sensor, data for 24 sensors.

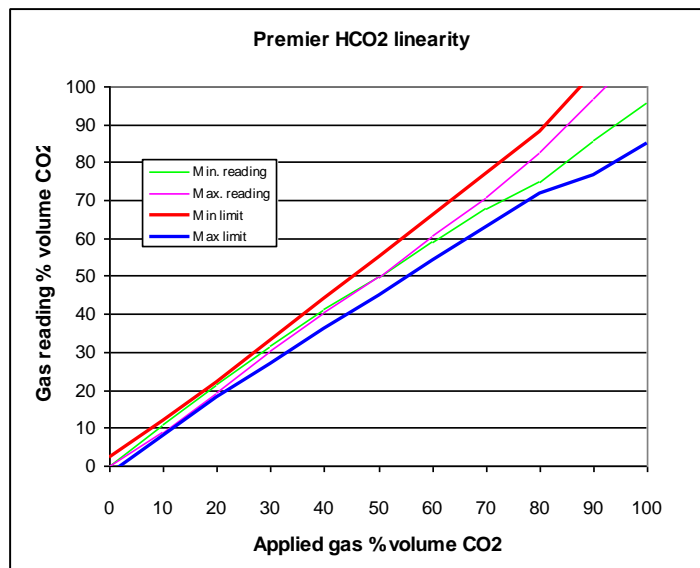

Calibration options

Dynamant recommend a maximum interval of 12 months between calibration checks. A small amount of zero drift can be accommodated by re-zeroing the gas detector against the sensor. The degree of drift that is acceptable should be determined by the user. Note that the subsequent change in gas reading will be greater than the change in zero reading.

The Dual Gas sensor has four ranges in all.

Range 1	0-5% volume methane
Range 2	0-100% volume methane
Range 3	0-2% volume propane
Range 4	0-100% volume carbon dioxide

If the sensor requires either a “Zero” or “Span” adjustment, there are two methods that can be used:

- 1) By using the “Premier Configuration Unit”
When used in conjunction with dedicated PC software, this device uses the data communication pins on the sensor to provide a means of calibration.
- 2) By using the data communications pins and software written in accordance with the protocol supplied by Dynamant.

Gas calibration is best carried out at 100% of the full scale for ranges 2 & 4 and at 50% of the full scale for ranges 1 & 3. Other calibration levels, between 10% and 100% of the range can be used but may affect the accuracy of the readings.

If the calibration gas level is entered incorrectly there will be an error in the calibration. It is the user’s responsibility to ensure that the calibration procedure is correctly applied. Checks on the correct calibration gas level that are used during span operations should be implemented within the calibration routine of the host gas detector’s firmware.

In all cases ensure that the sensor has been powered long enough for the temperature to have stabilised before starting the calibration. This time will vary in accordance with the way in which the sensor is mounted.

Note: a zero calibration must always be carried out before a span calibration.

CALIBRATE EACH GAS TYPE INDIVIDUALLY – DO NOT USE A MIXTURE OF CH₄ AND CO₂ IN THE SAME CYLINDER. DOING SO WILL RESULT IN AN INCORRECT CALIBRATION.

Sensor warm-up time

Digital output behaviour:

When power is first applied to the sensor, the digital output is held at -250% of the full scale for the duration of the “warm-up” time.

Note: The duration of the “warm-up” time can be pre-programmed to alternative values at the time of ordering sensors and later configured via the configuration unit.

Temperature transients and gas flow rates.

The Premier sensor employs a pyroelectric detector, the output from which can be disrupted by sudden changes in temperature. If there is an excessive change in the ambient temperature, gas sample temperature or flow rate, then the output signal will be momentarily frozen. Correct operation is restored when the effects of the transient have settled. Rates of change in the ambient temperature should be restricted to 2°C/minute and gas flow rates kept below 600 cc/minute.

Power supply considerations

The sensor power supply rise time must be less than 50 mS to ensure correct operation. Operation outside the range of 3 – 5 V dc will result in either fault indication, or the sensor will not function correctly.

Sensor over-range condition

The sensor will continue to provide an output up to a pre-determined percentage of the full-scale value; at this point the reading is clamped, regardless of any further increase in detected gas level. The over-range value should be specified when ordering; choose from the following values 100%, 125%, 150% and 200%. The linearity of the output is only guaranteed up to the full scale for the sensor; the over-range condition for the host instrument should therefore be determined by the user.

Sensor fault indication

The sensor constantly performs checks on the internal memory contents, the incoming supply voltage and the analogue signal values. These checks are used to ensure that the sensor is operating within its correct parameters, and that no internal faults have developed.

If a fault condition is detected, the output reading is set to the -250% full scale value.

Digital interface

The digital communication pins “RX” and “TX” operate at a 2.8V logic level. When interfacing to external circuitry that uses a higher voltage level it is necessary to limit the current that can flow. The external voltage level should be 5V maximum and a 3K3 resistor should be used in series with each communication pin.

The Rx and Tx voltage limits are as follows:

RX - VIH: Input ‘High’ minimum voltage - $0.8 V_{DD} = 2.24V$

RX - VIL: Input ‘Low’ maximum voltage - $0.2 V_{DD} = 0.56V$

TX - VOH: Output ‘High’ minimum voltage - $V_{DD} - 0.7 = 2.1$

TX - VOL: Output ‘Low’ maximum voltage - 0.6V

The digital output is a UART format comprising 8 data bits, 1 stop bit and no parity. Refer to specification for available baud rates. Contact Dynament Ltd for protocol details.

Known Bugs (SIL Only)

SIL1 (firmware version 07.17.00U) certified sensors are not suitable for use with 4800 baud rate.

GENERAL SPECIFICATION

Operating Voltage Range:	3.0 – 5.0 V d.c.
Operating Current:	Constant current operation, current range 75 – 85mA
Operating temperature range:	-20°C to +50°C (-4°F to 122°F)
Warm up time:	To final zero \pm 2% full scale : Approximately 1 minute @ 20°C (68°F) ambient, some sensors may take longer
Storage temperature range:	-20°C to +50°C (-4°F to 122°F)
Humidity range:	0 to 95% RH non-condensing.
Digital signal format:	8 data bits, 1 stop bit, no parity. 2.8V logic level
Standard baud rates:	38,400, 19,200, 9600, 4800
User configurable parameters:	Full-scale value, resolution, Sensor 'zero' function Sensor 'span' function
MTBF:	> 5 years
Weight:	15 grams
Pressure	Accuracy limits are maintained at pressures within \pm 5% of the calibration pressure.
User configurable parameters and functions:	Sensor 'zero' function Sensor 'span' function Over-range value

MECHANICAL DETAIL

NOTES

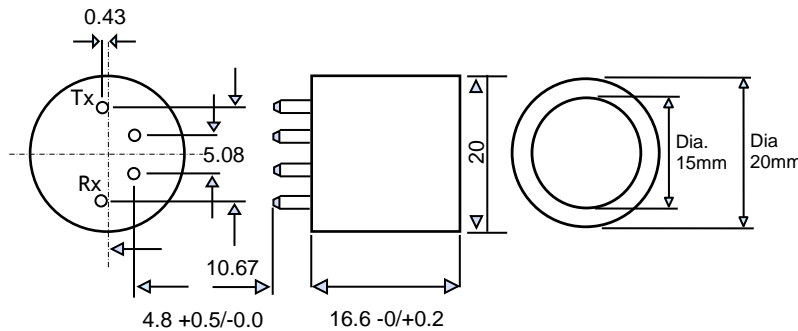

1. TOLERANCE: +/- 0.15 UNLESS OTHERWISE STATED.
2. RECOMMENDED PCB SOCKET
WEARNES CAMBION LTD
CODE: 450-3326-01-06-00.
3. **USE ANTI-STATIC PRECAUTIONS WHEN HANDLING**
4. **DO NOT CUT PINS**
5. **DO NOT SOLDER DIRECTLY TO PINS**
6. THE LABELLING ADDS UP TO 0.2 TO THE OUTER DIAMETER, AND UP TO 0.2 TO THE OVERALL HEIGHT

All dimensions are in millimetres. Pins viewed from underside
Diameter of pins = 1.5 +/- 0.05
Tx & Rx communication connections are available as either pads or pins

HYDROCARBON CHANNEL SPECIFICATION @ 20°C (68°F) ambient

Methane measuring range:	0-5%, 0-100% volume or both
Propane measuring range	0-2% volume
Resolution:	0.01% for readings up to 5% volume methane 0.1% for readings from 5% up to 100% volume methane 0.01% propane for all readings
Linearity:	The output is linear within $\pm 10\%$ of the applied gas, or $\pm 0.05\%$ volume, whichever is greater.
Accuracy: At 20°C, 1 bar atmospheric pressure, calibration gas applied	$\pm 2\%$
Response Time T₉₀:	<30s
Zero Repeatability:	$\pm 0.05\%$ volume methane, $\pm 0.03\%$ volume propane
Span Repeatability:	$\pm 0.1\%$ volume methane at 5% applied gas. $\pm 2\%$ volume methane at 100% applied gas. $\pm 0.06\%$ volume propane at 2% applied gas.
Long term zero drift:	$\pm 0.05\%$ volume methane per month $\pm 0.03\%$ volume propane per month
Temperature performance: * May not be applicable when using gas cross-reference factors	$\pm 0.1\%$ volume or $\pm 10\%$ of reading up to 50% of full scale, $\pm 15\%$ of reading from 50% to 100% of full scale, or 2% of full scale whichever is greater over the range -20°C to +50°C (-4°F to 122°F)

CARBON DIOXIDE CHANNEL SPECIFICATION @ 20°C (68°F) ambient

Measuring ranges:	0-10% volume up to 0-100% volume
Resolution:	0.1% for all readings
Accuracy: At 20°C, 1 bar atmospheric pressure, calibration gas applied	$\pm 2\%$
Linearity:	The linearity at ambient temperature is $\pm 3\%$ full scale or $\pm 10\%$ of the reading up to 80% full scale and $\pm 15\%$ of the reading from 80% to 100% full scale, whichever is greater.
Response Time T₉₀:	<30s
Zero Repeatability:	$\pm 2\%$ of full scale
Span Repeatability:	$\pm 2\%$ of full scale
Long term zero drift:	$\pm 1\%$ of full scale / month
Operating temperature range:	-20°C to +50°C (-4°F to 122°F)
Temperature performance:	$\pm 10\%$ of reading up to 50% of full scale and $\pm 15\%$ of reading from 50% to 100% of full scale over the range -20°C to +50°C (-4°F to 122°F)

Warranty information

All Dynament Platinum sensors carry a five-year warranty against defects in materials and workmanship. The warranty is invalidated if the sensors are used under conditions other than those specified in this data sheet.

Attention should be paid to the following criteria:

- **Observe the correct supply polarity**
- **Do not exceed the maximum rated supply voltage of 5V**
- **Do not solder directly to the sensor pins**
- **Do not expose the sensor to corrosive gases such as hydrogen sulphide**
- **Do not allow condensation to take place within the sensor**

Dynament reserve the right to alter technical specifications, without prior notice, when it is appropriate to implement a technical enhancement that leads to improved performance. Should any changes be required that could affect the customer's use of the product, Dynament will endeavour to contact customers directly to inform them of the changes.

Ordering Details

In order to completely specify the type of sensor that is required, the customer needs to provide the following information (more information available on TDS0052 Platinum Sensor Ordering Codes): -

- An Order Code (see below) that specifies the sensors' basic physical and electrical characteristics.
- The sensor configuration requirements, including the required gas measurement ranges.

EXAMPLE OF ORDER CODES

MSH – DS / HC / HCO2 / NC / P / F

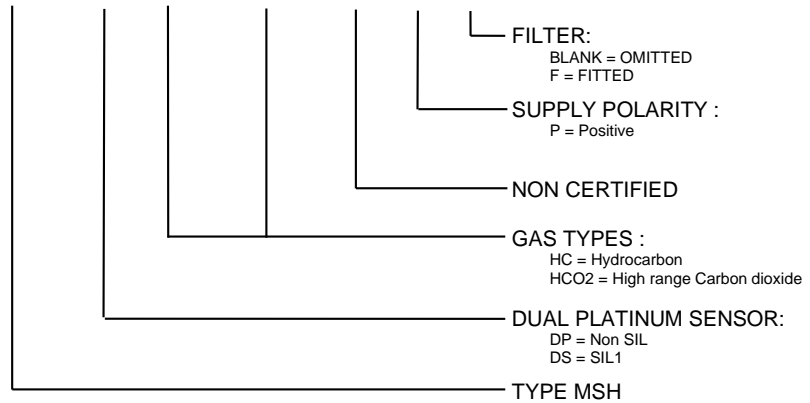

CONFIGURATION OPTIONS

(To be stated on customer order in addition to the Order Code)

1. Communication speed – 38,400 baud (default), specify alternative rate if required.
2. Over-range value: 100%, 125%, 150% and 200% of full-scale value.

Dual Premier Pin-Out

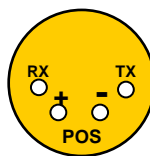

Dual Premier Positive Polarity