

LOW POWER VERSION
TRIPLE RANGE HYDROCARBON SENSOR
Non Exd Certified

***** Available in EN50271 / SIL1 Certified versions *****

SIL1



MSH2-LS/HC/NC

Non - SIL



MSH2-LP/HC/NC

- *Use 80% less power than the other product ranges*
- *Drop-in replacement*
- *No loss of performance*
- *Uses the same well established technology*

FEATURES

- ★ High resolution infrared sensor measures methane from 0 to 100% volume with a resolution of 0.01 % for 0-5% methane and 0.1% for 5-100% volume.
- ★ Can be configured for either methane, 0-100% or propane 0-2% volume measurements.
- ★ Combines all the features of the well-proven range of Premier hydrocarbon sensors, enabling the accurate measurement of 0-100% vol. methane with one sensor.
- ★ Offers reduced response times when compared with earlier versions.
- ★ Contains all the necessary optics, electronics and firmware to provide a linearised, temperature-compensated output for both methane and propane.
- ★ Choice of output format – digital output (floating point and binary), direct pellistor replacement or industry standard 0.4 to 2 volts.
- ★ Manual calibration option can be performed without digital commands.
- ★ User configurable using USB powered Premier Configuration Unit.
- ★ Analogue output is scaleable in % volume or % LEL.
- ★ Enhanced EMC protection
- ★ Internal Flash memory allowing sensor firmware updates via configuration equipment.

Dynamant Limited

Hermitage Lane Industrial Estate · Kings Mill Way · Mansfield · Nottinghamshire · NG18 5ER · UK.

Tel: 44 (0)1623 663636 · Fax: 44 (0)1623 421063

email: sales@dynamant.com · www.dynamant.com

DESCRIPTION

Dynamant infrared sensors operate by using the NDIR principle to monitor the presence of the target gas. The sensor contains a long life tungsten filament infrared light source, an optical cavity into which gas diffuses, a dual temperature compensated pyroelectric infrared detector, an integral semiconductor temperature sensor and electronics to process the signals from the pyroelectric detector .

Two versions are available:-

3 Pin Version - Pellistor Replacement Infrared

These sensors provide a pellistor style linearised, temperature-compensated output as shown in Graph 1.

They can either be supplied pre-set to customer specification or may be configured by the user by means of a configuration unit available from Dynamant Ltd. The output signal can be set to rise or fall with increase in the gas level.

Note that because the sensor supply current varies during operation, it is possible that this version of the sensor may not be suitable for all pellistor based instruments, without some modifications.

5 Pin Version - Multi-Purpose Range

This version of the sensor provides maximum user flexibility by providing the following output options:-

- Industry Standard 0.4 to 2 volt linearised, temperature-compensated output as shown in Graph 2, or alternative voltages for zero and full-scale outputs.
- Digital output for direct communications with instrument electronics.
- Rising or falling output with increasing gas level for the pellistor replacement, bridge output as shown in graph 1.

The digital output is a UART format comprising 8 data bits, 1 stop bit and no parity.

Refer to specification for available baud rates. Contact Dynamant Ltd for protocol details.

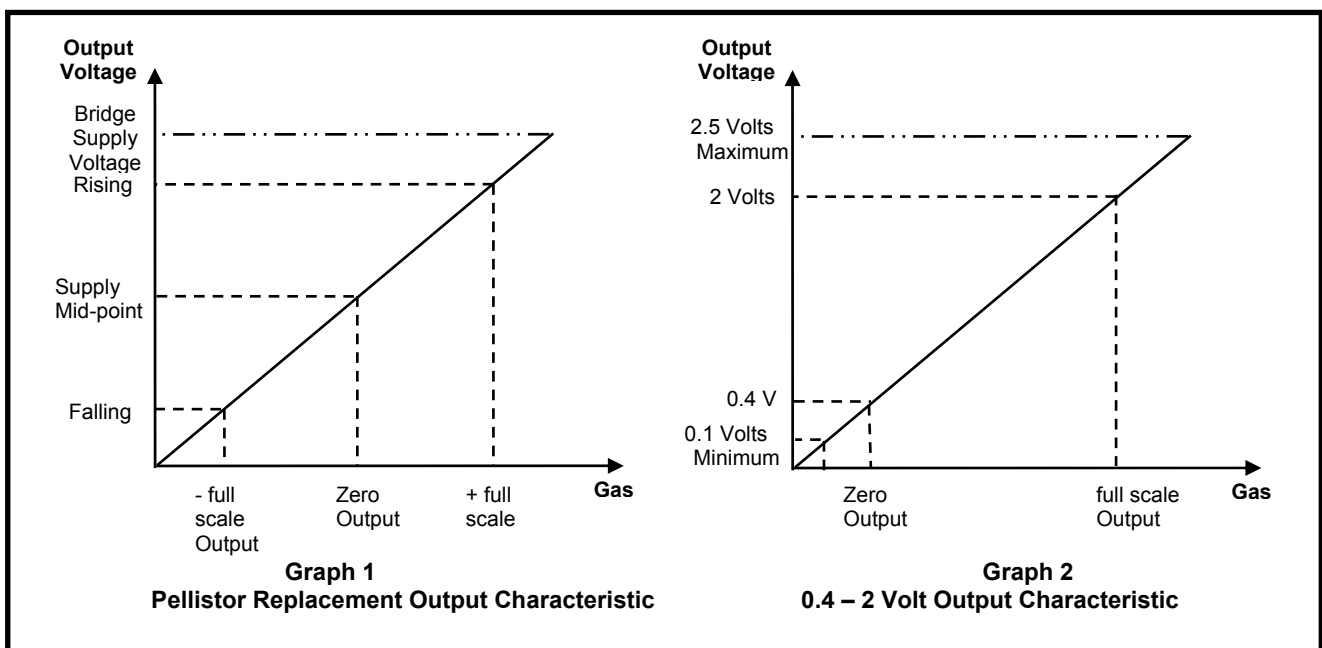

Patent Protection

The sensor design is protected by the following Patents

Great Britain	GB 2 401 432 & GB 2 403 291
Europe	EP 1544603 & EP 1818667-Pending
France	EP [FR] 1544603
Germany	EP [DE] 1544603
Italy	EP [I] 1544603
Switzerland	EP [CH] 1544603
USA	7, 244, 939
Other World Patents Pending	

Relative Response Characteristics

The Premier High Resolution methane sensor is calibrated to provide an output signal linearised for 0-100% volume methane during manufacture.

However, the sensor will also respond to a range of other hydrocarbon gases. The following graph shows the relative response to some of the common hydrocarbons.

These characteristics can be used as a guide to setting up the associated instrument alarm levels.

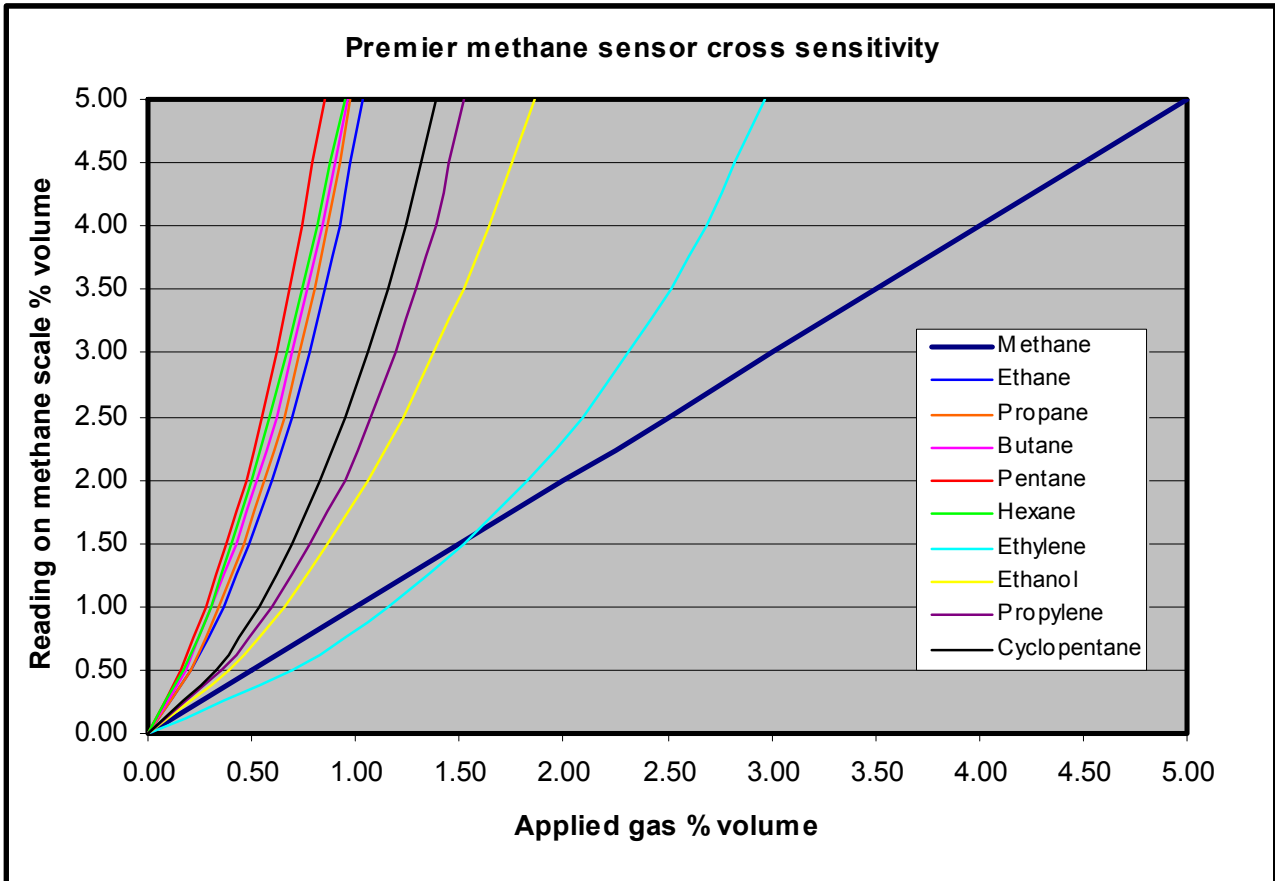

Note – Refer to data sheet TDS0050 for additional cross reference data

Temperature Compensation

The Premier sensor is temperature compensated over the range of -20°C to +50°C C or -40°C to +75°C for the XTR version.

The output variation is $\pm 0.1\%$ volume methane or $\pm 10\%$ of the reading for the range 0 to 5% volume, whichever is greater.

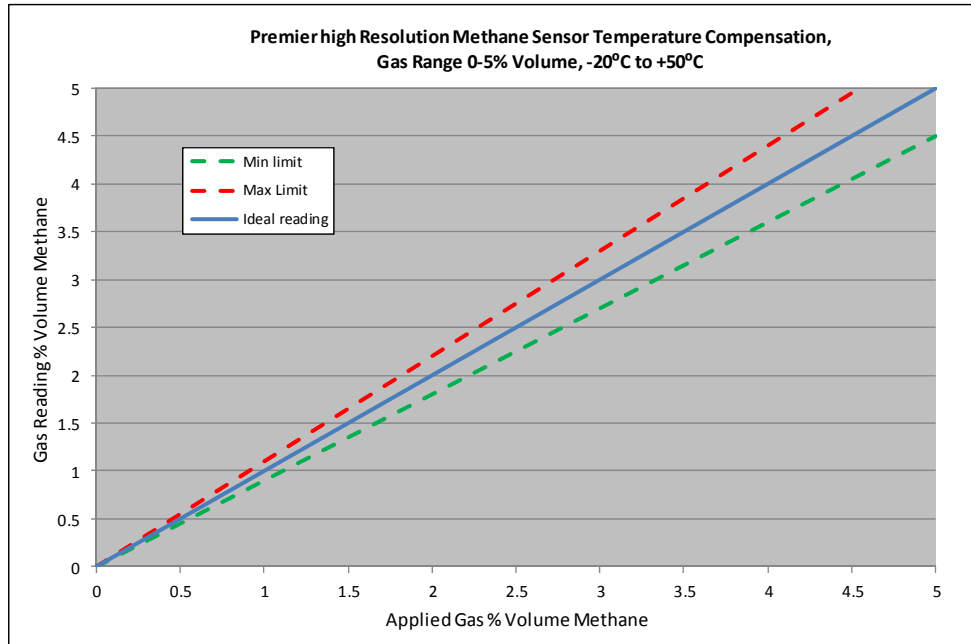

For the range 5% to 100% volume the output variation is $\pm 10\%$ of the reading.

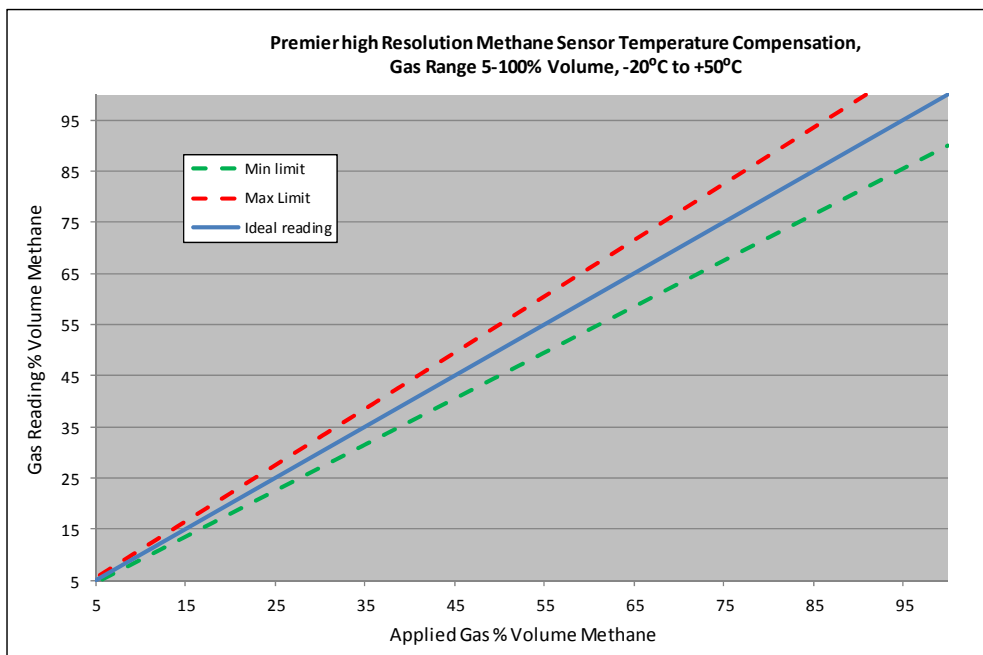

Linearity

The linearity at ambient temperature is $\pm 10\%$ of the reading across the full measuring range.

The following graphs show actual test data for linearity over the ranges 0-5% volume and 5-100% volume.

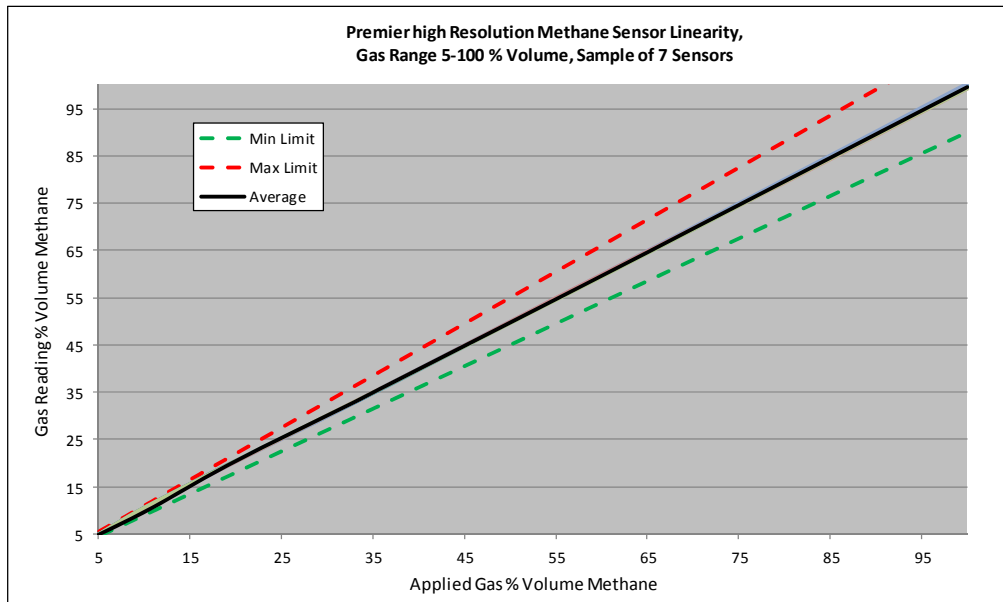
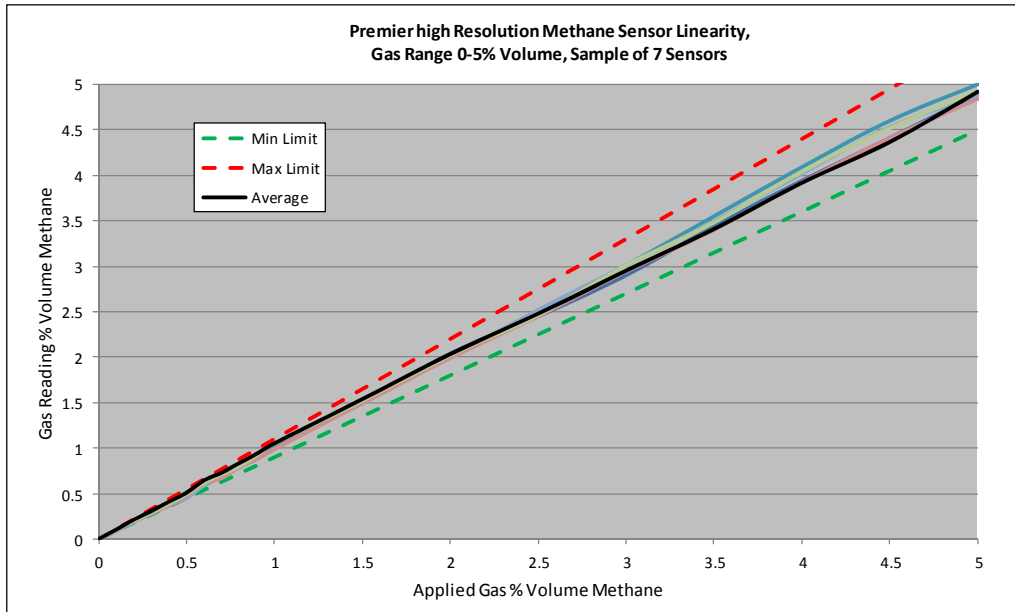

Calibration options

Dynamant recommend a maximum interval of 12 months between calibration checks. A small amount of zero drift can be accommodated by re-zeroing the gas detector against the sensor. The degree of drift that is acceptable should be determined by the user. Note that the subsequent change in gas reading will be greater than the change in zero reading.

The Hi-Res Gas sensor has three ranges in all.

Range 1	0-5% volume methane
Range 2	0-100% volume methane
Range 3	0-2% volume propane or other hydrocarbon

If the sensor requires either a “Zero” or “Span” adjustment, there are two methods that can be used:

1) By using the “Premier Configuration Unit”

When used in conjunction with dedicated PC software, this device uses the data communication pins on the sensor to provide a means of calibration.

2) By using the data communications pins and software written in accordance with the protocol supplied by Dynamant.

Gas calibration is best carried out at 50% of the range for ranges 1, & 3 and at 100% for range 2. Other calibration levels, between 10% and 100% of the range can be used but may affect the accuracy of the readings.

If the calibration gas level is entered incorrectly for any range, there will be an error in the calibration. It is the user’s responsibility to ensure that the calibration procedure is correctly applied. Checks on the correct calibration gas level that are used during span operations should be implemented within the calibration routine of the host gas detector’s firmware.

Note: a zero calibration must always be carried out before a span calibration.

Sensor warm-up time

When power is first applied to the sensor, the voltage at the output pin is held at a pre-determined level. The default setting for this start-up value is the “zero gas” value. This condition is maintained for a default “warm-up” time of 45 seconds, after this time the output voltage represents the calculated gas value. Sensors can take up to 1 minute to indicate the correct gas reading.

Note: the sensor can calculate any reading from -100% FSD to +200% FSD in the first minute. The output value that is read using the communications pins is always held at -250% FSD during the “warm-up” time.

Both the voltage at the output pin during the “warm-up” time, and the duration of the “warm-up” time can be pre-programmed to alternative values at the time of ordering sensors.

Temperature transients and gas flow rates.

The Premier sensor employs a pyroelectric detector, the output from which can be disrupted by sudden changes in temperature. If there is an excessive change in the ambient temperature, gas sample temperature or flow rate, then the output signal will be momentarily frozen. Correct operation is restored when the effects of the transient have settled. Rates of change in the ambient temperature should be restricted to 2°C/minute and gas flow rates kept below 600 cc/minute.

Power supply considerations

The sensor power supply rise time must be less than 50 mS to ensure correct operation. Operation outside the range of 3 – 5 V dc will result in either fault indication, or the sensor will not function correctly.

The current consumption varies during the program cycle at a rate of 2Hz. The peak current is 34mA, the current whilst the infrared source is powered is 20mA and the current whilst the source is turned off is 7.5mA.

The average current with a 3V power supply is 15mA.

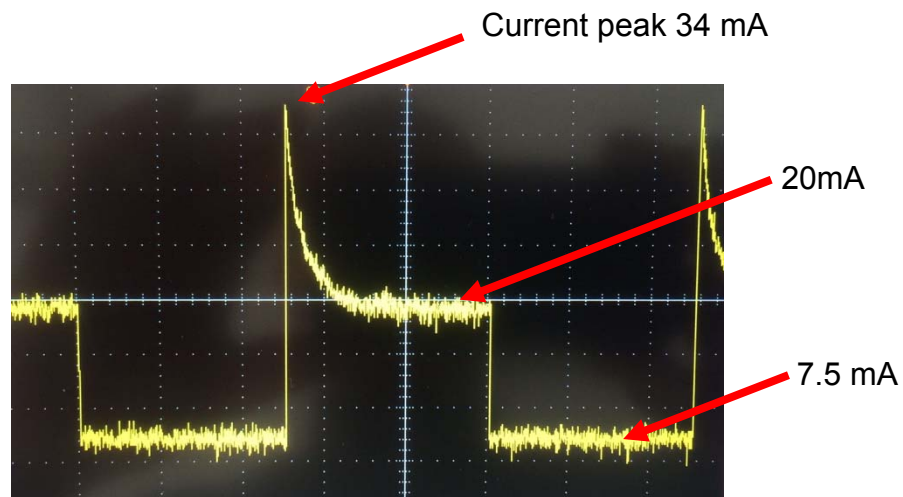

Current waveform for Premier low power sensor.

Sensor over-range condition

The sensor will continue to provide an output up to a pre-determined percentage of the full scale value; at this point the reading is clamped, regardless of any further increase in detected gas level. The over-range value should be specified when ordering; choose from the following values 100%, 125%, 150% and 200% The linearity of the output is only guaranteed up to the full scale for the sensor; the over-range condition for the host instrument should therefore be determined by the user.

Sensor fault indication

The sensor constantly performs checks on the internal memory contents, the incoming supply voltage and the analogue signal values. These checks are used to ensure that the sensor is operating within its correct parameters, and that no internal faults have developed.

If a fault condition is detected:

- 1) the output will be set to 0V.
- 2) The output value that is read when using the communications pins, instead of the voltage output pin, will be set to -250% full-scale.

As mentioned in the "Sensor warm-up time" section above, the voltage at the output pin during the warm-up time can be specified when ordering sensors.

Digital interface

The digital communication pins "RX" and "TX" operate at a 2.8V logic level. When interfacing to external circuitry that uses a higher voltage level it is necessary to limit the current that can flow. The external voltage level should be 5V maximum and a 3K3 resistor should be used in series with each communication pin.

The Rx and Tx voltage limits are as follows:

RX - VIH: Input 'High' minimum voltage - $0.8 V_{DD} = 2.24V$

RX - VIL: Input 'Low' maximum voltage - $0.2 V_{DD} = 0.56V$

TX - VOH: Output 'High' minimum voltage - $V_{DD} - 0.7 = 2.1$

TX - VOL: Output 'Low' maximum voltage - $0.6V$

Refer to tds0045 Communication Protocol for further details.
Contact Dynament Ltd. to obtain the document.

SPECIFICATION @ 20°C (68°F) ambient temperature	
Operating Voltage Range:	3.0 – 5.0 V d.c.
Operating Current:	Average current 15mA. See graph on page 9
Programmable Output Voltage Ranges:	Voltage Output Types – 0.1V to 2.7V d.c. Bridge Output Types – 0v to Bridge Supply Voltage
Methane measuring range:	0-5%, 0-100% volume, or both
Propane measuring range:	0-2% volume
Resolution:	0.01% for readings up to 5% volume methane 0.1% for readings from 5% up to 100% volume methane 0.01% propane for all readings Output voltage resolution 42.7 μ V.
Linearity:	The output is linear within \pm 10% of the gas reading.
Warm up time:	To final zero \pm 2% full-scale: 1 minute
Accuracy:	\pm 10% of the reading @ 20°C (68°F), 1 bar pressure, applied gas.
Pressure	\pm 5% of the calibration pressure to maintain the accuracy limits
Methane response Time T₅₀:	<10s
Methane response Time T₉₀:	<30s
Propane response Time T₅₀:	<10s
Propane response Time T₉₀:	<30s
Zero Repeatability:	\pm 0.05% volume methane
Span Repeatability:	\pm 0.1% volume methane at 5% applied gas. \pm 2% volume methane at 100% applied gas.
Long term zero drift:	\pm 0.05% volume methane per month
Operating temperature range:	-20°C to +50°C (-4°F to 122°F)
Temperature performance over the range -20°C to +50°C(-4°F to 122°F): <small>* May not be applicable when using gas cross-reference factors</small>	\pm 0.1% volume or \pm 10% of reading up to 50% of full scale, \pm 15% of reading from 50% to 100% of full scale, or 2% of full scale whichever is greater over the range -20°C to +50°C (-4°F to 122°F)
Temperature performance over the range -40°C to +75°C(-40°F to 167°F): <small>* May not be applicable when using gas cross-reference factors</small>	\pm 0.1% volume or \pm 10% of reading up to 50% of full scale, \pm 15% of reading from 50% to 100% of full scale, or 2% of full scale whichever is greater over the range -40°C to +75°C (-40°F to 167°F)
Storage temperature range:	-20°C to +50°C (-4°F to 122°F) -40°C to +75°C (-40°F to 167°F) for XTR version
Humidity range:	0 to 95% RH non-condensing.
Digital signal format:	8 data bits, 1 stop bit, no parity. 2.8V logic level
Standard baud rates:	38,400, 19,200, 9600, 4800
User configurable parameters and functions:	Zero output voltage Full-scale output voltage Positive or negative going output Sensor 'zero' function Sensor 'span' function Over-range value
MTBF:	> 5 years
Weight :	15 grams

MECHANICAL DETAIL

NOTES

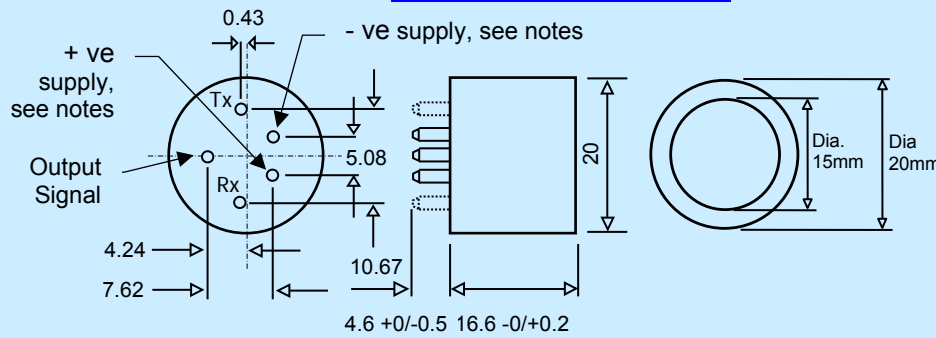

1. TOLERANCE: +/- 0.15 UNLESS OTHERWISE STATED.
2. RECOMMENDED PCB SOCKET WEARNES CAMBION LTD CODE: 450-3326-01-06-00.
3. **USE ANTI-STATIC PRECAUTIONS WHEN HANDLING**
4. **DO NOT CUT PINS**
5. **DO NOT SOLDER DIRECTLY TO PINS**
6. THE LABELLING ADDS UP TO 0.2 TO THE OUTER DIAMETER, AND UP TO 0.2 TO THE OVERALL HEIGHT

All dimensions are in millimetres. Pins viewed from underside
Diameter of pins = 1.5 +/- 0.05
Tx & Rx communication connections are available as either pads or pins

NOTE – The above pin configuration is shown for the POSITIVE version of the sensor. The NEGATIVE version has the +ve and –ve supply pin positions exchanged. See ordering details.

Warranty information

All Dynament Premier sensors carry a five year warranty against defects in materials and workmanship. The warranty is invalidated if the sensors are used under conditions other than those specified in this data sheet.

Particular attention should be paid to the following criteria:

- **Observe the correct supply polarity**
- **Do not exceed the maximum rated supply voltage of 5V**
- **Do not solder directly to the sensor pins**
- **Do not expose the sensor to corrosive gases such as hydrogen sulphide**
- **Do not allow condensation to take place within the sensor**

Dynament reserve the right to alter technical specifications, without prior notice, when it is appropriate to implement a technical enhancement that leads to improved performance. Should any changes be required that could affect the customer's use of the product, Dynament will endeavour to contact customers directly to inform them of the changes.

Ordering Details

In order to completely specify the type of sensor that is required, the customer needs to provide the following information:-

- An Order Code (see below) that specifies the sensors' basic physical and electrical characteristics.
- The sensor configuration requirements.

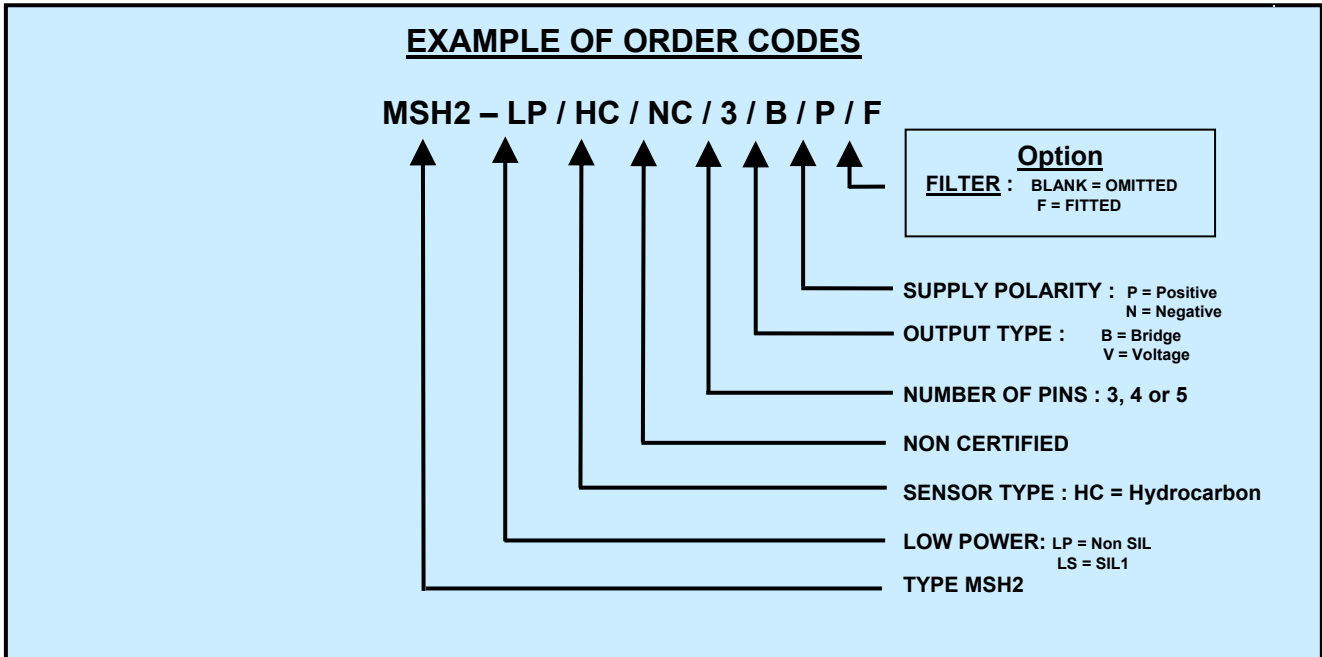

- CONFIGURATION OPTIONS**
(To be stated on customer order in addition to the Order Code)
1. Output voltage for zero.
 2. Output voltage for span.
 3. Rising or falling output voltage with increasing gas level (for "Bridge" outputs)
 4. Sensitivity e.g. 100 mV = 100 % volume CH₄ for "Bridge" outputs, 0.4 – 2.4V = 100% volume methane for "Voltage" output sensors.
 5. Communication speed – 38,400 baud (default), specify alternative rate if required.
 6. Over-range value: 100%, 125%, 150% and 200% of full-scale value.
 7. Add /XTR suffix for extended temperature range.

Pellistor Replacement - Explanation of Positive & Negative Polarity

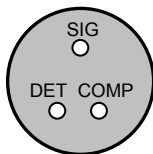

Typical Pellistor Pinout

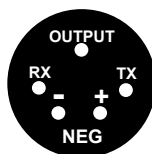

Premier Negative Polarity Option

Use where the DET pin of the existing pellistor is connected to the Negative of the pellistor bridge supply.

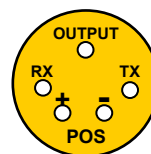

Premier Positive Polarity Option

Use where DET pin of the existing pellistor is connected to the Positive of the pellistor bridge supply.

Note – On the 3 pin version of the sensor, the RX and TX connections are pads, not pins.