

**LOW POWER VERSION**  
**DUAL HYDROCARBONS AND CARBON DIOXIDE SENSOR**  
**Exd Certified VERSIONS**

**\*\*\* Available in EN50271 / SIL1 Certified versions \*\*\***

**SIL1**



**MSH2-LS/HC/CO2**  
**MSH2ia-LS/HC/CO2**

**Non - SIL**



**MSH2-LD/HC/CO2**  
**MSH2ia-LD/HC/CO2**

- **Use 80% less power than the other product ranges, whilst delivering two independent gas sensor channels**
- **Equivalent current per sensor channel of only 7.5mA**
- **Drop-in replacement**
- **No loss of performance**
- **Uses the same well-established technology**

**FEATURES**

- ★ Combines all the features of the hydrocarbon and carbon dioxide Premier sensors, enabling the measurement of two different gases with one sensor.
- ★ No increase in physical size or power consumption when compared with a single gas Premier sensor. Ideal for portable, battery powered instruments.
- ★ Contains all the necessary optics, electronics and firmware to provide THREE linearised, temperature-compensated measurements: Methane, propane and carbon dioxide.
- ★ Digital output for direct interface to host circuitry.
- ★ The hydrocarbon channel can be used to measure methane from 0 to 100% volume with an auto-ranging feature that provides the optimum resolution in both the % LEL range and the % volume range. Has equal performance to a 0-5% volume methane sensor AND a 0-100% volume methane sensor.
- ★ The storage of multiple calibration, temperature compensation and linearisation data enables simultaneous readings from the hydrocarbon channel for high resolution methane AND a 0-2% volume propane range.
- ★ All sensor types are user configurable using configuration equipment available from Dynamant.
- ★ Enhanced EMC protection.
- ★ Internal Flash memory allowing sensor firmware updates via configuration equipment.

**Dynamant Limited**

Hermitage Lane Industrial Estate • Kings Mill Way • Mansfield • Nottinghamshire • NG18 5ER • UK.

Tel: 44 (0)1623 663636 •

email: [sales@dynamant.com](mailto:sales@dynamant.com) • [www.dynamant.com](http://www.dynamant.com)

## DESCRIPTION

Dynamant infrared sensors operate by using the NDIR principle to monitor the presence of target gas. The sensor contains a long life tungsten filament infrared light source, an optical cavity into which gas diffuses, temperature compensated pyroelectric infrared detectors, an integral semiconductor temperature sensor and electronics to process the signals from the pyroelectric detector .

The sensor uses a digital output for direct communications with instrument electronics. The digital output is a UART format comprising 8 data bits, 1 stop bit and no parity. Refer to specification for available baud rates.

## Patent Protection

The sensor design is protected by the following Patents

Great Britain	GB 2 401 432 & GB 2 403 291
Europe	EP 1544603 & EP 1818667-Pending
France	EP [ FR ] 1544603
Germany	EP [ DE ] 1544603
Italy	EP [ I ] 1544603
Switzerland	EP [ CH ] 1544603
USA	7, 244, 939
Other World Patents	Pending

## Hydrocarbon Response Characteristics

The Premier range of hydrocarbon infrared gas sensors are calibrated to provide an output signal linearised for a specific gas type and concentration during manufacture.

However, the sensor will also respond to a range of other hydrocarbon gases. The following graphs show the relative response of a methane sensor, and a propane sensor, to some of the common hydrocarbons.

These characteristics can be used as a guide to setting up the associated instrument alarm levels.

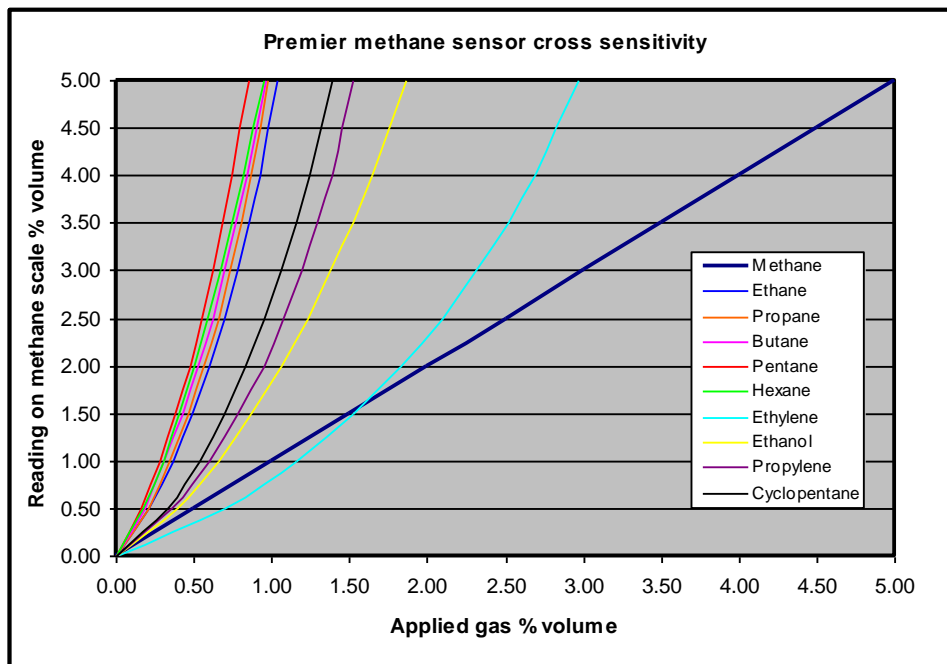

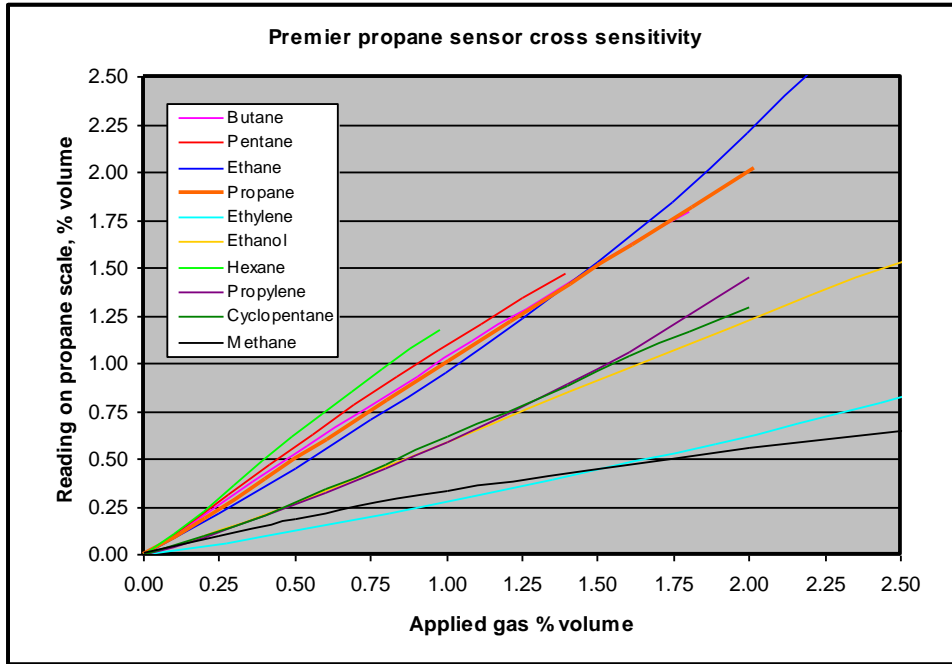

Note – Refer to data sheet TDS0050 for additional cross reference data

### Hydrocarbon Temperature Compensation

The Premier sensor is temperature compensated over the range of -20°C to +50°C. The output variation is  $\pm 2\%$  FSD or  $\pm 10\%$  of the reading up to 50% FSD and  $\pm 15\%$  of the reading from 50% to 100% FSD, which ever is greater.

The following graph is based on the hydrocarbon sensor being characterised for methane.

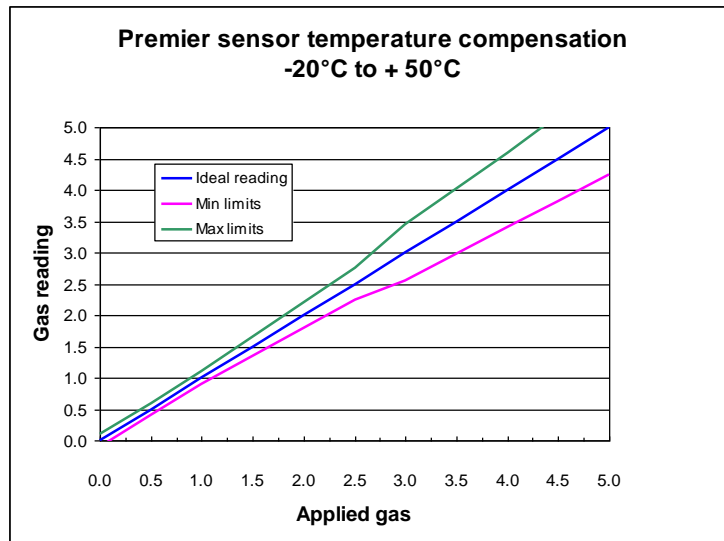

## Hydrocarbon Linearity

The Premier sensor linearity at ambient temperature is  $\pm 2\%$  FSD or  $\pm 10\%$  of the reading which ever is greater.

The following graph is based on the hydrocarbon sensor being characterised for methane, data based on 24 sensors.

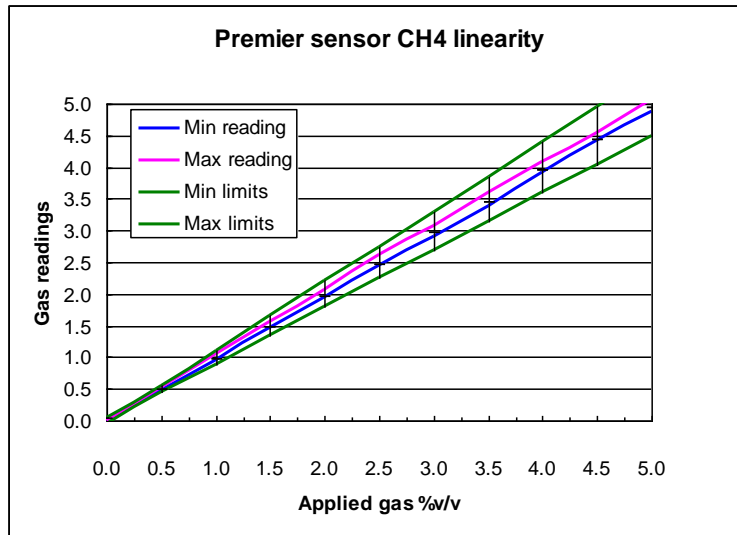

## Carbon dioxide Temperature Compensation

The Premier sensor is temperature compensated over the range of  $-20^{\circ}\text{C}$  to  $+50^{\circ}\text{C}$ . The output variation is  $\pm 0.1\%$  v/v or  $\pm 10\%$  of the reading up to 50% FSD and  $\pm 15\%$  of the reading from 50% to 100% FSD, which ever is greater.

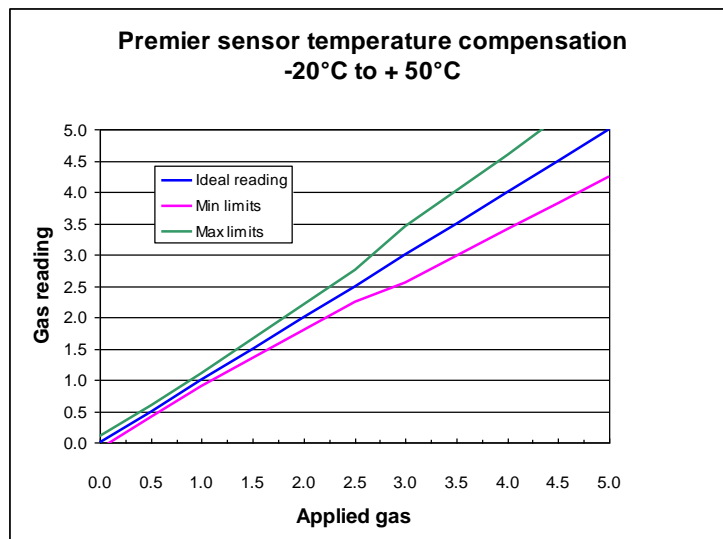

## Carbon dioxide Linearity

The Premier sensor linearity at ambient temperature is  $\pm 2\%$  FSD or  $\pm 10\%$  of the reading which ever is greater.

The following graph is based on the 0-5% v/v sensor, data for 24 sensors.

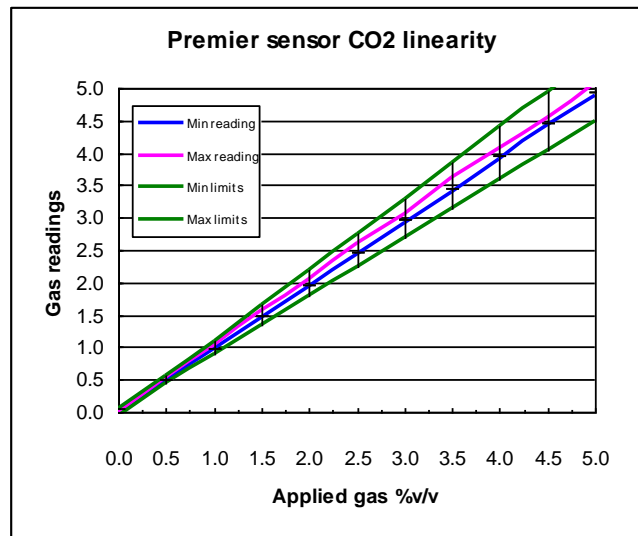

## Calibration options

Dynamant recommend a maximum interval of 12 months between calibration checks. A small amount of zero drift can be accommodated by re-zeroing the gas detector against the sensor. The degree of drift that is acceptable should be determined by the user. Note that the subsequent change in gas reading will be greater than the change in zero reading.

The Dual Gas sensor has four ranges in all.

Range 1	0-5% volume methane
Range 2	0-100% volume methane
Range 3	0-2% volume propane
Range 4	0-5% volume carbon dioxide

If the sensor requires either a "Zero" or "Span" adjustment, there are two methods that can be used:

1) By using the "Premier Configuration Unit"

When used in conjunction with dedicated PC software, this device uses the data communication pins on the sensor to provide a means of calibration.

2) By using the data communications pins and software written in accordance with the protocol supplied by Dynamant.

Gas calibration is best carried out at 50% of the range for ranges 1, 3 & 4 and at 100% for range 2. Other calibration levels, between 10% and 100% of the range can be used but may affect the accuracy of the readings.

If the calibration gas level is entered incorrectly for any range, there will be an error in the calibration. It is the user's responsibility to ensure that the calibration procedure is correctly applied. Checks on the correct calibration gas level that are used during span operations should be implemented within the calibration routine of the host gas detector's firmware.

**Note: a zero calibration must always be carried out before a span calibration**

## Sensor warm-up time

When power is first applied to the sensor, the voltage at the output pin is held at a pre-determined level. The default setting for this start-up value is the “zero gas” value. This condition is maintained for a default “warm-up” time of 45 seconds, after this time the output voltage represents the calculated gas value. Sensors can take up to 1 minute to indicate the correct gas reading.

Note: the sensor can calculate any reading from -100% FSD to +200% FSD in the first minute. The output value that is read using the communications pins is always held at -250% FSD during the “warm-up” time.

The duration of the “warm-up” time can be pre-programmed to alternative values at the time of ordering sensors, the range being 45 to 120 seconds.

## Temperature transients and gas flow rates.

The Premier sensor employs a pyroelectric detector, the output from which can be disrupted by sudden changes in temperature. If there is an excessive change in the ambient temperature, gas sample temperature or flow rate, then the output signal will be momentarily frozen. Correct operation is restored when the effects of the transient have settled. Rates of change in the ambient temperature should be restricted to 2°C/minute and gas flow rates kept below 600 cc/minute.

## Power supply considerations

The sensor power supply rise time must be less than 50 mS to ensure correct operation. Operation outside the range of 3 – 5 V dc will result in either fault indication, or the sensor will not function correctly.

The current consumption varies during the program cycle at a rate of 2Hz. The peak current is 36mA, the current whilst the infrared source is powered is 20mA and the current whilst the source is turned off is 7mA.

The average current with a 3V power supply is 15mA.

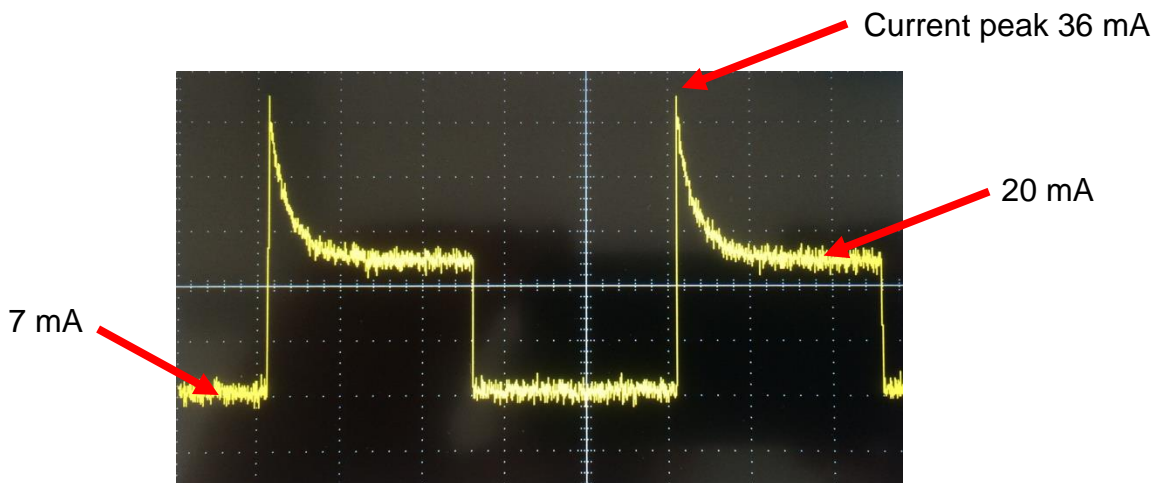

Current waveform for Premier low power sensor.



## Sensor over-range condition

The sensor will continue to provide an output up to a pre-determined percentage of the full-scale value; at this point the reading is clamped, regardless of any further increase in detected gas level. The over-range value should be specified when ordering; choose from the following values 100%, 125%, 150% and 200%. The linearity of the output is only guaranteed up to the full scale for the sensor; the over-range condition for the host instrument should therefore be determined by the user.

## Sensor fault indication

The sensor constantly performs checks on the internal memory contents, the incoming supply voltage and the analogue signal values. These checks are used to ensure that the sensor is operating within its correct parameters, and that no internal faults have developed.

If a fault condition is detected, the output reading is set to the -250% full scale value.

## Digital interface

The digital communication pins "RX" and "TX" operate at a 2.8V logic level. When interfacing to external circuitry that uses a higher voltage level it is necessary to limit the current that can flow. The external voltage level should be 5V maximum and a 3K3 resistor should be used in series with each communication pin.

The Rx and Tx voltage limits are as follows:

RX - VIH: Input 'High' minimum voltage -  $0.8 V_{DD} = 2.24V$

RX - VIL: Input 'Low' maximum voltage -  $0.2 V_{DD} = 0.56V$

TX - VOH: Output 'High' minimum voltage -  $V_{DD} - 0.7 = 2.1$

TX - VOL: Output 'Low' maximum voltage -  $0.6V$

Refer to tds0045 Communication Protocol for further details.  
Contact Dynament Ltd. to obtain the document.

## Known Bugs (SIL Only)

SIL1 ( firmware version 07.17.00U) certified sensors are not suitable for use with 4800 baud rate.



<b>CERTIFICATION DETAILS</b>		
<b>European ATEX Certification</b>	<b>Sensor types MSH2-LP, MSH2-LS</b>	<b>Sensor types MSH2ia-LP, MSH2ia-LS</b>
<b>Approval body</b>	<b>FTZU</b>	<b>FTZU</b>
<b>Certificate Number</b>	<b>FTZU 14 ATEX 0213U (See footnote 2)</b>	<b>FTZU 14 ATEX 0213U (See footnote 2)</b>
<b>Test Standards</b>	<b>EN 60079-0:2012+A11:2013 EN 60079-1:2014 EN 60079-11:2012 EN 50303:2000</b>	<b>EN 60079-0:2012+A11:2013 EN 60079-1:2014 EN 60079-11:2012 EN 50303:2000</b>
<b>Certification Codes</b>	<b>I M2 Ex db I Mb II 2 G Ex db IIC Gb</b>	<b>I M1 Ex db ia I Ma II 2 G Ex db IIC Gb</b>
<b>Input parameters</b>	<b>0.8W max, 30V max. (See footnote)</b>	<b>Ui=6V dc, Pi=0.8W (See footnote)</b>
<b>Operating temperature</b>	<b>-20°C to +60°C (See footnote 1)</b>	
<b>International IECEx Certification</b>	<b>Sensor types MSH2-LP, MSH2-LS</b>	<b>Sensor types MSH2ia-LP, MSH2ia-LS</b>
<b>Approval body</b>	<b>FTZU</b>	<b>FTZU</b>
<b>Certificate Number</b>	<b>IECEx FTZU 15.0002U (See footnote 2)</b>	<b>IECEx FTZU 15.0002U (See footnote 2)</b>
<b>Test Standards</b>	<b>IEC60079-0:2011, Edition 6 IEC60079-1:2007-04, Edition 6</b>	<b>IEC60079-0:2011, Edition 6 IEC60079-1:2007-04, Edition 6 IEC60079-11:2011, Edition 6</b>
<b>Certification Codes</b>	<b>Ex d I Mb Ex db IIC Gb</b>	<b>Ex d ia I Ma Ex db IIC Gb</b>
<b>Input parameters</b>	<b>0.8W max, 30V max.</b>	<b>Ui=6V dc, Pi=0.8W</b>
<b>Operating temperature</b>	<b>-20°C to +60°C (See footnote 1)</b>	
<b>North American Certification</b>	<b>Sensor type MSH2-LP</b>	<b>Sensor type MSH2ia-LP</b>
<b>Approval body</b>	<b>Underwriters Laboratory Inc.</b>	<b>Underwriters Laboratory Inc.</b>
<b>File Reference</b>	<b>E336365</b>	<b>E336365</b>
<b>Test Standards</b>	<b>UL 60079 – 0, 4<sup>th</sup> Edition UL 60079 - 1, 6<sup>th</sup> Edition CAN/CSA-C22.2 No. 60079-0-1-7 CAN/CSA-C22.2 No. 60079-1 part 1, 1<sup>st</sup> Edition</b>	<b>UL913 7<sup>th</sup>, Edition UL 60079 – 0, 4<sup>th</sup>, Edition UL 60079 – 11, 2<sup>nd</sup>, Edition CAN/CSA-C22.2 No. 157-92</b>
<b>Hazardous Locations</b>	<b>Class 1, Zone 1, AEx d IIC and Ex d IIC Hazardous Locations</b>	<b>Class I, II, III, Division 1 Class 1, Zone 0, AEx ia IIC, T4 with 60°C ambient</b>

<b>Input/Entity parameters</b>	<b>0.8W max, 30V max.</b>	<b>Ui=6V dc, Pi=0.8W, Ci=4.105µF, Li=0 mH</b>
<b>Note1 Input parameters are defined for certification purposes only, refer to the "Specification" table for the sensor operating voltage and temperature range.</b>		
<b>Note 2 SIL Certificate number for all variants is SIRA FSP 14002/01</b>		

<b>HYDROCARBON CHANNEL SPECIFICATION</b>	
<b>Methane measuring range:</b>	0-5%, 0-100% volume or both
<b>Hydrocarbon measuring range</b>	0-100% LEL equivalent
<b>Resolution:</b>	0.01% for readings up to 5% volume methane 0.1% for readings from 5% up to 100% volume methane 0.01% propane for all readings
<b>Accuracy:</b>	± 10% of the reading @ 20°C (68°F), 1 bar pressure, applied gas.
<b>Response Time T<sub>90</sub>:</b>	<30s @ 20°C (68°F) ambient
<b>Zero Repeatability:</b>	± 1% of full scale @ 20°C (68°F) ambient
<b>Span Repeatability:</b>	± 2% of full scale @ 20°C (68°F) ambient
<b>Long term zero drift:</b>	± 1% of full scale per month @20°C (68°F) ambient, (max ± 3% of full scale per year)
<b>Temperature performance:</b> <small>* May not be applicable when using gas cross-reference factors</small>	± 0.1% volume or ± 10% of reading up to 50% of full scale, ± 15% of reading from 50% to 100% of full scale, or 2% of full scale whichever is greater over the range -20°C to +50°C (-4°F to 122°F)
<b>User configurable parameters and functions:</b>	Sensor 'zero' function Sensor 'span' function Over-range value

<b>CARBON DIOXIDE CHANNEL SPECIFICATION</b>	
<b>Measuring ranges:</b>	0 - 1%, 0-2%, 0-5% volume CO <sub>2</sub>
<b>Resolution:</b>	0.01% for all readings
<b>Accuracy:</b>	± 10% of the reading @ 20°C (68°F), 1 bar pressure, applied gas.
<b>Response Time T<sub>90</sub>:</b>	<30s @ 20°C (68°F) ambient
<b>Zero Repeatability:</b>	± 500ppm @ 20°C (68°F) ambient
<b>Span Repeatability:</b>	± 500ppm @ 20°C (68°F) ambient
<b>Long term zero drift:</b>	± 500ppm / month @ 20°C (68°F) ambient
<b>Operating temperature range:</b>	-20°C to +50°C (-4°F to 122°F)
<b>Operating Voltage Range:</b>	3.0 - 5.8 V d.c.
<b>Operating Current:</b>	± 10% of reading up to 50% of full scale and ± 15% of reading from 50% to 100% of full scale over the range -20°C to +50°C. Average current 15mA. See graph on page 6
<b>Operating temperature range:</b>	-20°C to +50°C (-4°F to 122°F)
<b>Warm up time:</b>	To final zero ± 2% full scale : Approximately 1 minute @ 20°C (68°F) ambient, some sensors may take longer
<b>Storage temperature range:</b>	-20°C to +50°C (-4°F to 122°F)
<b>Humidity range:</b>	0 to 95% RH non-condensing.
<b>Digital signal format:</b>	8 data bits, 1 stop bit, no parity. 2.8V logic level
<b>Standard baud rates:</b>	38,400, 19,200, 9600, 4800
<b>User configurable parameters:</b>	Full-scale value, resolution, Sensor 'zero' function Sensor 'span' function
<b>MTBF:</b>	> 5 years
<b>Weight:</b>	15 grams
<b>Pressure</b>	± 5% of the calibration pressure to maintain the accuracy limits

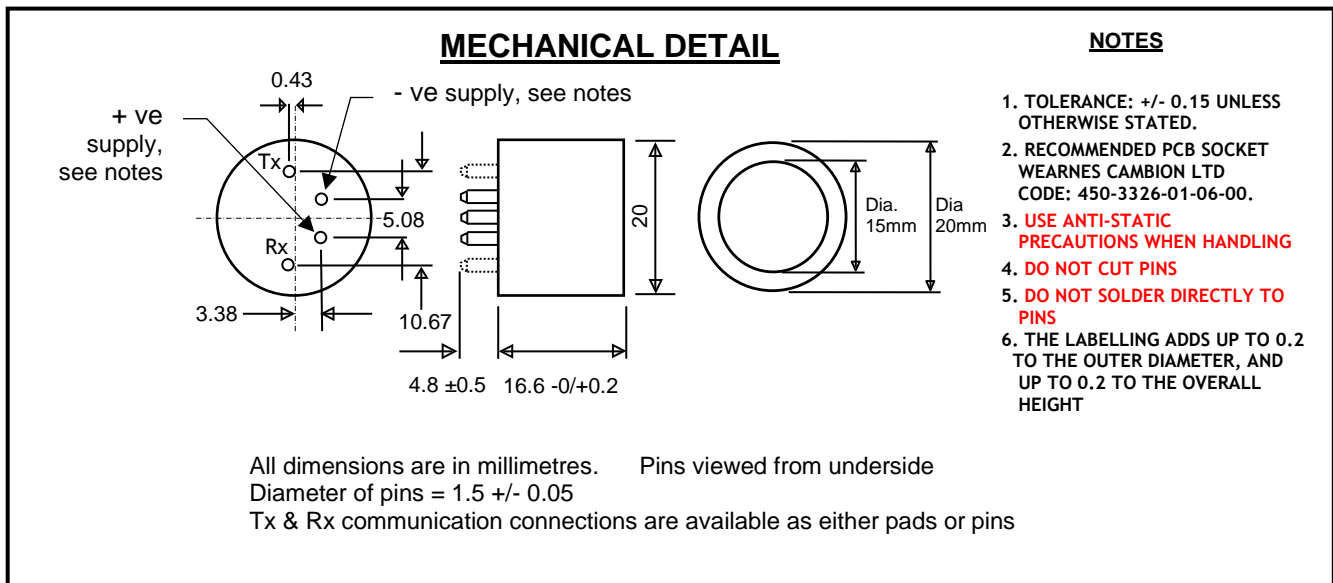

**NOTE – Positive polarity pin configuration.**

### Warranty information

All Dynament Premier sensors carry a five-year warranty against defects in materials and workmanship. The warranty is invalidated if the sensors are used under conditions other than those specified in this data sheet.

Attention should be paid to the following criteria:

- **Observe the correct supply polarity**
- **Do not exceed the maximum rated supply voltage of 5V**
- **Do not solder directly to the sensor pins**
- **Do not expose the sensor to corrosive gases such as hydrogen sulphide**
- **Do not allow condensation to take place within the sensor**

Dynament reserve the right to alter technical specifications, without prior notice, when it is appropriate to implement a technical enhancement that leads to improved performance. Should any changes be required that could affect the customer’s use of the product, Dynament will endeavour to contact customers directly to inform them of the changes.

## Ordering Details

In order to completely specify the type of sensor that is required, the customer needs to provide the following information:-

- An Order Code (see below) that specifies the sensors' basic physical and electrical characteristics.
- The sensor configuration requirements.

**EXAMPLE OF ORDER CODES**

**MSH2 – LD / HC / CO2 / P / F**

↑

↑

↑

↑

↑

↑

Option

**FILTER :** BLANK = OMITTED  
F = FITTED

SUPPLY POLARITY :  
P = Positive

GAS TYPES :  
HC = Hydrocarbon  
CO2 = Carbon dioxide

LOW POWER DUAL SENSOR  
LD = Non SIL  
LS = SIL1

TYPE MSH2 or MSH2ia (For Mining M1 applications only)

---

**CONFIGURATION OPTIONS**  
(To be stated on customer order in addition to the Order Code)

1. Communication speed – 38,400 baud (default), specify alternative rate if required.
2. Over-range value: 100%, 125%, 150% and 200% of full-scale value.

## Dual Premier Pin-Out

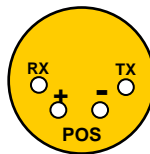

**Dual Premier Positive  
Polarity**