

**PREMIER *PLATINUM* INFRARED HYDROCARBON SENSOR  
TYPE MSH-P-HCP/NC/XTR**

**For operation from -40°C to +75°C**

Great Britain  
Europe  
France  
Germany  
Italy  
Switzerland  
USA

Patent Numbers  
GB 2 401 432 & GB 2 403 291  
EP 1544603 & EP 1818667-Pending  
EP [ FR ] 1544603  
EP [ DE ] 1544603  
EP [ I ] 11544603  
EP [ CH ] 1544603  
7, 244, 939

Other World Patents Pending



**FEATURES**

- ★ SPECIFICALLY DESIGNED TO COMPLY WITH CSA 22.2 No. 152, this sensor is an extended temperature range version of the Premier hydrocarbon sensor suitable for use from -40°C to +75°C.
- ★ Response times optimised to meet the t50 and t90 times as defined by CSA 22.2 No. 152
- ★ Contains all the necessary optics, electronics and firmware to provide a linearised, temperature-compensated output.
- ★ Choice of output format – digital output (floating point and binary), direct pellistor replacement or industry standard 0.4 to 2 volts.
- ★ Manual calibration option can be performed without digital commands.
- ★ User configurable using USB powered Premier Configuration Unit.
- ★ Analogue output is scaleable in % volume or % LEL.
- ★ Internal Flash memory allowing sensor firmware updates via configuration equipment.
- ★ Enhanced EMC protection.

**Dynamant Limited**

Hermitage Lane Industrial Estate · Kings Mill Way · Mansfield · Nottinghamshire · NG18 5ER · UK.

Tel: 44 (0)1623 663636

email: [sales@dynamant.com](mailto:sales@dynamant.com) · [www.dynamant.com](http://www.dynamant.com)

## DESCRIPTION

These 'Premier' sensors are designed to enable users to achieve Certification to CSA standard 22.2 No. 152.

Please note that the sensors themselves do not carry any CSA certification.

Dynamant infrared sensors operate by using the NDIR principle to monitor the presence of target gas. The sensor contains a long life tungsten filament infrared light source, an optical cavity into which gas diffuses, a dual temperature compensated pyroelectric infrared detector, an integral semiconductor temperature sensor and electronics to process the signals from the pyroelectric detector .

Two versions are available:-

### 3 Pin Version - Pellistor Replacement Infrared

These sensors provide a pellistor style linearized, temperature-compensated output as shown in Graph 1.

They can either be supplied pre-set to customer specification or may be configured by the user by means of a configuration unit available from Dynamant Ltd. The output signal can be set to rise or fall with increase in the gas level.

### 5 Pin Version - Multi-Purpose Range

This version of the sensor provides maximum user flexibility by providing the following output options:-

- ★ Industry Standard 0.4 to 2 volt linearized, temperature-compensated output as shown in Graph 2, or alternative voltages for zero and full scale outputs.
- ★ Digital output for direct communications with instrument electronics.
- ★ Rising or falling output with increasing gas level.

The digital output is a UART format comprising 8 data bits, 1 stop bit and no parity. Refer to specification for available baud rates. Contact Dynamant Ltd for protocol details.

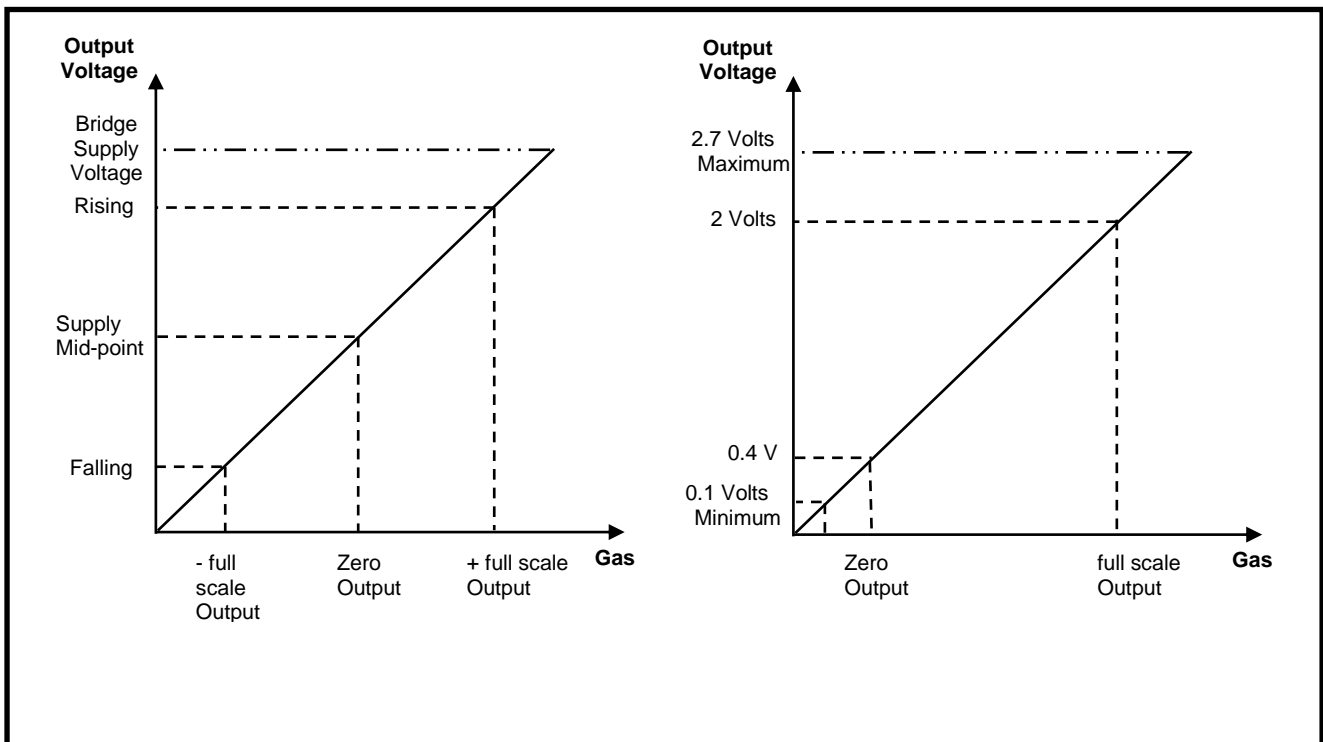

## Hydrocarbon Response Characteristics

The Premier range of hydrocarbon infrared gas sensors are calibrated to provide an output signal linearised for a specific gas type and concentration during manufacture.

However, the sensor will also respond to a range of other hydrocarbon gases. The following graphs show the relative response of a methane sensor, and a propane sensor, to some of the common hydrocarbons.

These characteristics can be used as a guide to setting up the associated instrument alarm levels.

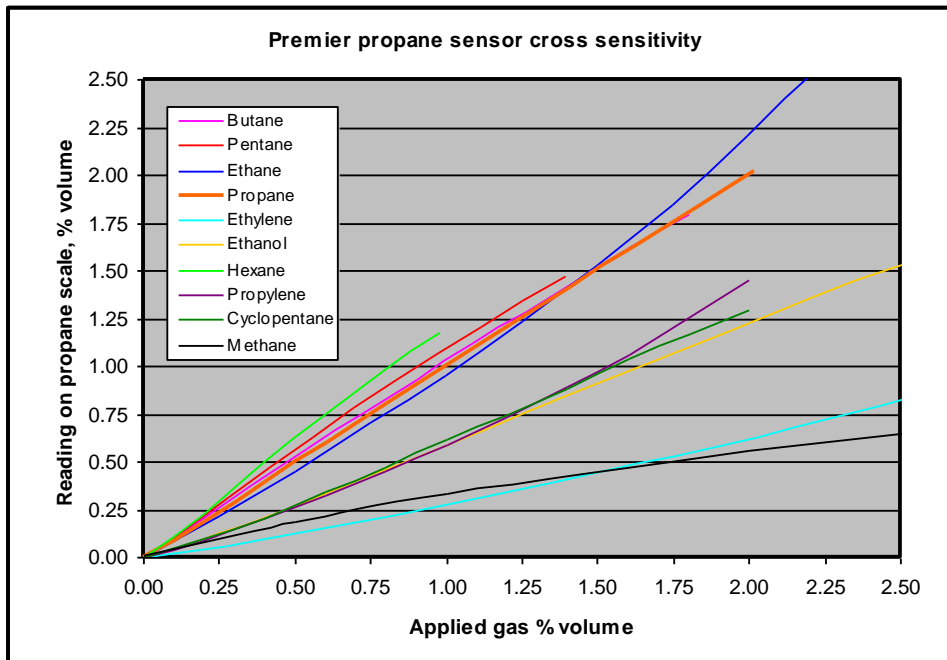
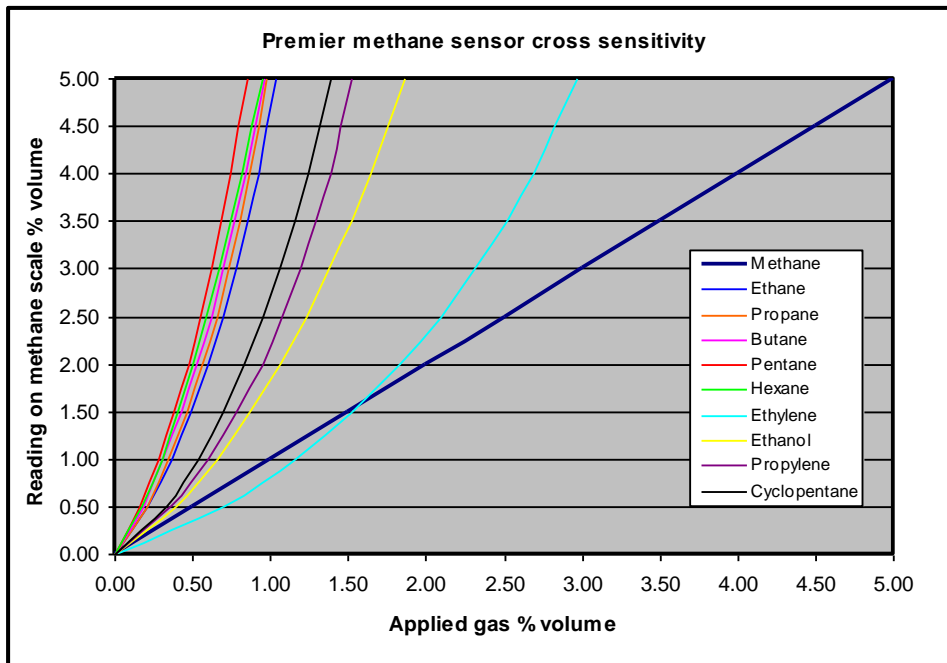

Note – Refer to data sheet tds0050 for additional cross reference data

## Temperature Compensation

The Premier "CSA" version sensor is temperature compensated over the range of -40°C to +75°C and meets the following criteria in the context of CSA 22.2 No. 152 :

### Stationary gas detection instruments:

As defined by clause 6.12.1 of CSA 22.2 No. 152. (Refer to this standard for more specific details regarding the scope of this clause)

**Following application of 50% of the full scale gas concentration at 0°C then 40° the concentration indicated at the output shall not vary from the reading, after calibration with half-scale gas at ambient temperature, by more than ±3% of the full scale gas concentration.**

### Stationary gas detection instruments with remote detector heads:

As defined by clause 6.12.2 of CSA 22.2 No. 152. (Refer to this standard for more specific details regarding the scope of this clause)

**Following application of 50% of the full scale gas concentration at:**

- a) normal ambient
- b) -40°C
- c) -25°C
- d) +75°C

**In each case the concentration indicated at the output shall not vary from the reading at ambient temperature by more than the following:**

**From -25°C or +75°C the deviation shall not exceed ±5% of full scale gas concentration.**

**From -40°C the deviation shall not exceed ±10% of full scale gas concentration.**

Note: In order to achieve optimum accuracy it is recommended that a calibration using half scale gas is performed before testing. Allow the sensor's temperature to fully stabilise before calibration. The length of time required for stabilisation will depend upon the sensor's mounting arrangement and the ambient temperature.

## Accuracy

The Premier "CSA" version sensor meets the accuracy test as defined by clause 6.15 of CSA 22.2 No. 152.

**"Following exposure to test gases corresponding to 10%, 25%, 50%, 75% and 100% of the full scale gas concentration, in each case the concentration indicated at the output shall not vary from the actual test gas concentration by more than the following:**

- a) For test gas concentrations up to and including 50% of full scale, the deviation shall not exceed  $\pm 3\%$  of full scale gas concentration.**
- b) For test gas concentrations above 50% of full scale, the deviation shall not exceed  $\pm 5\%$  of full scale gas concentration."**

Tests may be performed at an ambient temperature of 20°C to 30°C provided that the temperature is held constant within  $\pm 2^\circ\text{C}$  for the duration of each test.

Note: In order to achieve optimum accuracy it is recommended that a calibration using half scale gas is performed before testing. Allow the sensor's temperature to fully stabilise before calibration. The length of time required for stabilisation will depend upon the sensor's mounting arrangement and the ambient temperature.

## Response times

The Premier "CSA" version sensor meets the Step Change Response test as defined by clause 6.9 of CSA 22.2 No. 152.

**"Beginning with the sensor in clean air it shall be suddenly exposed to 100% full scale gas. From the instant of exposure to gas the sensor shall respond within the time specified as follows:**

**50% of full scale gas – 10 seconds**

**90% of full scale gas – 30 seconds**

## Calibration options

Dynamet recommend a maximum interval of 12 months between calibration checks. A small amount of zero drift can be accommodated by re-zeroing the gas detector against the sensor. The degree of drift that is acceptable should be determined by the user. Note that the subsequent change in gas reading will be greater than the change in zero reading. If the sensor requires either a "Zero" or "Span" adjustment, there are three methods that can be used:

- 1) By using the "Premier Configuration Unit"  
When used in conjunction with dedicated PC software, this device uses the data communication pins on the sensor to provide a means of calibration. Refer to data sheet TDS0043 for additional information.
- 2) By using the data communications pins and software written in accordance with the protocol supplied by Dynamet.
- 3) By using the "Manual Calibration" feature.  
"Zero" and "Span" operations can be performed by momentarily connecting the data communication pins to the negative supply pin. Refer to data sheet TDS0064 for full instructions.

## Sensor warm-up time

When power is first applied to the sensor, the voltage at the output pin is held at a pre-determined value, by default, this is the “zero gas” value. This condition is maintained for a default “warm-up” time of 45 seconds, after this time the output voltage represents the calculated gas value. Sensors can take up to 1 minute to indicate the correct gas reading.

Note: the sensor can output any reading from -100% full scale to +200% full scale in the first minute. The output value that is read using the communications pins is always held at zero during the “warm-up” time.

Both the voltage at the output pin during the “warm-up” time, and the duration of the “warm-up” time can be pre-programmed to alternative values at the time of ordering sensors.

## Temperature transients and gas flow rates.

The Premier sensor employs a pyroelectric detector, the output from which can be disrupted by sudden changes in temperature. If there is an excessive change in the ambient temperature, gas sample temperature or flow rate, then the output signal will be momentarily frozen. Correct operation is restored when the effects of the transient have settled. Rates of change in the ambient temperature should be restricted to 2°C/minute and gas flow rates kept below 600 cc/minute.

## Power supply considerations

The sensor power supply rise time must be less than 50 mS to ensure correct operation. Operation outside the range of 3 – 5 V dc will result in either fault indication, or the sensor will not function correctly.

## Sensor over-range condition

The sensor will continue to provide an output up to 200% of the full scale value; at this point the reading is clamped, regardless of any further increase in detected gas level. The linearity of the output is only guaranteed up to the full scale for the sensor; the over-range condition should therefore be determined and indicated by the host instrument.

## Sensor fault indication

The sensor constantly performs checks on the internal memory contents, the incoming supply voltage and the analogue signal values. These checks are used to ensure that the sensor is operating within its correct parameters, and that no internal faults have developed.

If a fault condition is detected, the output value is set to -100% full scale. In the case of a sensor with a voltage output that is scaled, 0.4 – 2.4V, for example, the output will be set to 0V under fault conditions

It is not recommended to choose an output voltage of 0V for zero-gas, because the fault condition cannot then be distinguished from the zero-gas condition.

The output value that is read when using the communications pins, instead of the voltage output pin, will be set to -100% full scale under fault conditions.

As mentioned in the “Sensor warm-up time” section above, the voltage at the output pin during the warm-up time can be specified when ordering sensors. It should be noted that if a start-up voltage is chosen that represents the zero-gas condition, then should a fault subsequently develop leaving the sensor unable to drive the output to -100% full scale, this condition cannot be detected by the host instrument.

The start-up voltage that is equivalent to zero-gas was chosen as the default setting because, in a large number of applications, the host instrument would otherwise indicate fault during the warm-up period.

## Digital interface

The digital communication pins “RX” and “TX” operate at a 2.8V logic level. When interfacing to external circuitry that uses a higher voltage level it is necessary to limit the current that can flow. The external voltage level should be 5V maximum and a 3K3 resistor should be used in series with each communication pin.

The Rx and Tx voltage limits are as follows:

RX - VIH: Input ‘High’ minimum voltage -  $0.8 V_{DD} = 2.24V$

RX - VIL: Input ‘Low’ maximum voltage -  $0.2 V_{DD} = 0.56V$

TX - VOH: Output ‘High’ minimum voltage -  $V_{DD} - 0.7 = 2.1$

TX - VOL: Output ‘Low’ maximum voltage -  $0.6V$

Contact Dynament Ltd for details of the required protocol.

## Known Bugs (SIL Only)

SIL1 ( firmware version 07.17.00U) certified sensors are not suitable for use with 4800 baud rate.

## SPECIFICATION

<b>Operating Voltage Range:</b>	3.0 – 5.0 V d.c.
<b>Operating Current:</b>	Constant current operation, current range 75 – 85mA
<b>Programmable Output Voltage Ranges:</b>	Voltage Output Types – 0v to 2.8 volts d.c. Bridge Output Types – 0v to Bridge Supply Voltage
<b>Methane measuring range:</b>	0 – 5% volume up to 0 – 100% volume
<b>Hydrocarbon measuring range:</b>	0 – 100% LEL equivalent
<b>Resolution:</b>	1% of measuring range for readings above 50% of range, 0.5% of measuring range for readings below 50% of range
<b>Warm up time:</b>	To final zero $\pm$ 2% full scale : Approximately 1 minute @ 20°C (68°F) ambient, some sensors may take longer
<b>Accuracy</b>	See page 5
<b>Temperature performance:</b>	See page 5
<small>* May not be applicable when using gas cross-reference factors</small>	
<b>Response Time T<sub>90</sub>:</b>	<30s @ 20°C (68°F) ambient
<b>Response Time T<sub>50</sub>:</b>	<10s @ 20°C (68°F) ambient
<b>Zero Repeatability:</b>	$\pm$ 1% full scale @ 20°C (68°F) ambient
<b>Span Repeatability:</b>	$\pm$ 2% full scale @ 20°C (68°F) ambient
<b>Long term zero drift:</b>	$\pm$ 1% full scale per month @20°C (68°F) ambient, (max $\pm$ 3% full scale per year)
<b>Operating temperature range:</b>	-40°C to +75°C (-40°F to 167°F)
<b>Storage temperature range:</b>	-40°C to +50°C (-4°F to 122°F)
<b>Humidity range:</b>	0 to 95% RH non-condensing.
<b>Digital signal format:</b>	8 data bits, 1 stop bit, no parity. 2.8V logic level
<b>Standard baud rates:</b>	38,400, 19,200, 9600
<b>User configurable parameters:</b>	Zero output voltage Full scale output voltage Positive or negative going output Sensor 'zero' function Sensor 'span' function Resolution
<b>MTBF:</b>	> 5 years
<b>Weight :</b>	15 grams

## MECHANICAL DETAILS

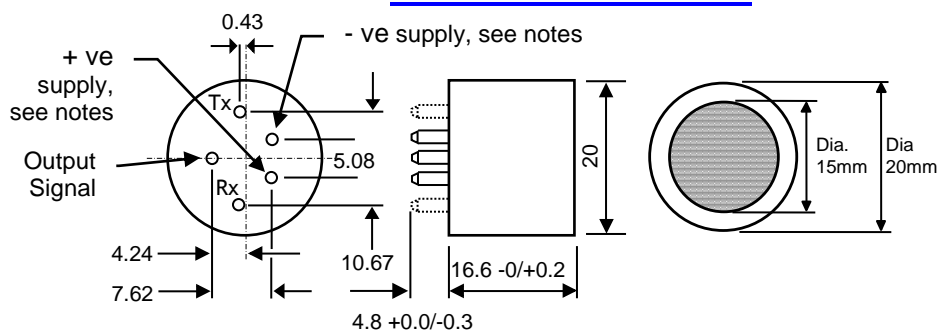

## NOTES

1. TOLERANCE: +/- 0.15 UNLESS OTHERWISE STATED.
2. RECOMMENDED PCB SOCKET WEARNES CAMBION LTD CODE: 450-3326-01-06-00.
3. **USE ANTI-STATIC PRECAUTIONS WHEN HANDLING**
4. **DO NOT CUT PINS**
5. **DO NOT SOLDER DIRECTLY TO PINS**
6. THE LABELLING ADDS UP TO 0.2 TO THE OUTER DIAMETER, AND UP TO 0.2 TO THE OVERALL HEIGHT

All dimensions re in millimetres. Pins viewed from underside  
 Diameter of pins = 1.5 +/- 0.05  
 Tx & Rx communication connections are available as either pads or pins

**NOTE – The above pin configuration is shown for the POSITIVE version of the sensor. The NEGATIVE version has the +ve and –ve supply pin positions exchanged. See ordering details.**



## Ordering Details

In order to completely specify the type of sensor that is required, the customer needs to provide the following information:-

- An Order Code (see below) that specifies the sensors' basic physical and electrical characteristics.
- The sensor configuration requirements.

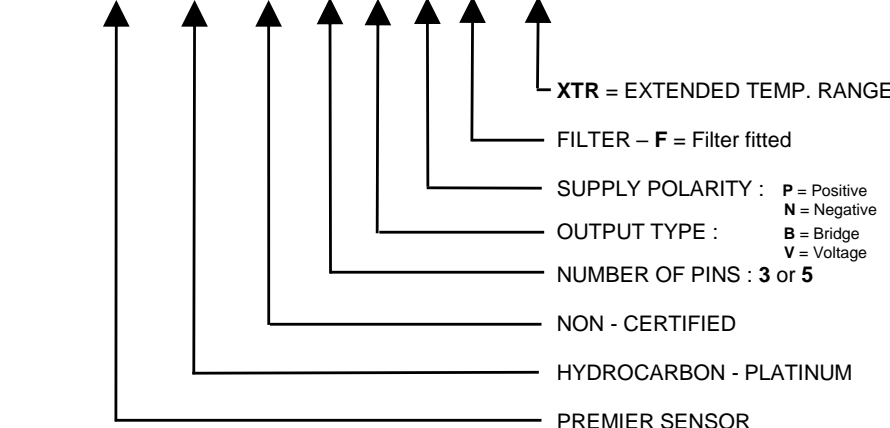
<p><b>Available sensor options:</b></p> <p>F = Replaceable, self adhesive microporous PTFE filter</p>	<h3>EXAMPLE OF ORDER CODES</h3> <p><b>MSH – P / HCP / NC / 3 / B / P / F / XTR</b></p>  <p>XTR = EXTENDED TEMP. RANGE          FILTER – F = Filter fitted          SUPPLY POLARITY : P = Positive          N = Negative          OUTPUT TYPE : B = Bridge          V = Voltage          NUMBER OF PINS : 3 or 5          NON - CERTIFIED          HYDROCARBON - PLATINUM          PREMIER SENSOR</p>
---	--

**CONFIGURATION OPTIONS**  
 (To be stated on customer order in addition to the Order Code)

1. Output voltage for zero.
2. Output voltage for span.
3. Rising or falling output voltage with increasing gas level.
4. Sensitivity e.g. 20 mV / % volume CH<sub>4</sub>.
5. Communication speed – 38,400 baud (default), specify alternative rate if required.

Note: Refer to data sheet TDS0115 for additional information

## Pellistor Replacement - Explanation of Positive & Negative Polarity

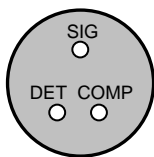

Typical Pellistor Pinout

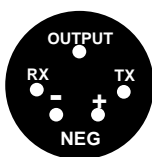

**Premier Negative Polarity Option**

Use where the DET pin of the existing pellistor is connected to the Negative of the pellistor bridge supply.

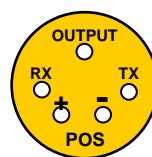

**Premier Positive Polarity Option**

Use where DET pin of the existing pellistor is connected to the Positive of the pellistor bridge supply.

Note – On the 3 pin version of the sensor, the RX and TX connections are pads, not pins.

## Warranty information

All Dynament Premier sensors carry a **five** year warranty against defects in materials and workmanship. The warranty is invalidated if the sensors are used under conditions other than those specified in this data sheet.

Particular attention should be paid to the following criteria:

- **Observe the correct supply polarity**
- **Do not exceed the maximum rated supply voltage of 5V**
- **Do not solder directly to the sensor pins**
- **Do not expose the sensor to corrosive gases such as hydrogen sulphide**
- **Do not allow condensation to take place within the sensor**

Dynament reserve the right to alter technical specifications, without prior notice, when it is appropriate to implement a technical enhancement that leads to improved performance. Should any changes be required that could affect the customer's use of the product, Dynament will endeavour to contact customers directly to inform them of the changes.