

**PREMIER HYDROCARBON INFRARED SENSOR
NON-CERTIFIED VERSION
TYPE MSH-P-HC-NC**



	Patent Numbers
Great Britain	GB 2 401 432 & GB 2 403 291
Europe	EP 1544603 & EP 1818667-Pending
France	EP [FR] 1544603
Germany	EP [DE] 1544603
Italy	EP [I] 1544603
Switzerland	EP [CH] 1544603
USA	7, 244, 939
	Other World Patents Pending

FEATURES

- ★ Contains all the necessary optics, electronics and firmware to provide a linearized, temperature-compensated output.
- ★ Choice of output format – direct pellistor replacement, industry standard 0.4 to 2 volts dc or digital.
- ★ Instantly converts existing compatible pellistor-based instruments to infrared.
- ★ Large range of gas calibration options available, e.g. methane, propane, butane etc.
- ★ Sensors can be factory configured to customer specification.
- ★ All sensor types are user configurable using configuration equipment available from Dynamant.
- ★ Fast track route for original equipment manufacturers to introduce the latest infrared technology – without any specialist knowledge.
- ★ Internal Flash memory allowing sensor firmware updates via configuration equipment.

Dynamant Limited

Hermitage Lane Industrial Estate · Kings Mill Way · Mansfield · Nottinghamshire · NG18 5ER · UK.

Tel: 44 (0)1623 663636 · Fax: 44 (0)1623 421063

email: sales@dynamant.com · www.dynamant.com

DESCRIPTION

Dynamant infrared sensors operate by using the NDIR principle to monitor the presence of target gas. The sensor contains a long life tungsten filament infrared light source, an optical cavity into which gas diffuses, a dual temperature compensated pyroelectric infrared detector, an integral semiconductor temperature sensor and electronics to process the signals from the pyroelectric detector .

Two versions are available:-

3 Pin Version - Pellistor Replacement Infrared

These sensors provide a pellistor style linearized, temperature-compensated output as shown in Graph 1.

They can either be supplied pre-set to customer specification or may be configured by the user by means of a configuration unit available from Dynamant Ltd. The output signal can be set to rise or fall with increase in the gas level.

5 Pin Version - Multi-Purpose Range

This version of the sensor provides maximum user flexibility by providing the following output options:-

- ★ Industry Standard 0.4 to 2 volt linearized, temperature-compensated output as shown in Graph 2, or alternative voltages for zero and full scale outputs.
- ★ Digital output for direct communications with instrument electronics.
- ★ Rising or falling output with increasing gas level.

The digital output is a UART format comprising 8 data bits, 1 stop bit and no parity. Refer to specification for available baud rates. Contact Dynamant Ltd for protocol details.

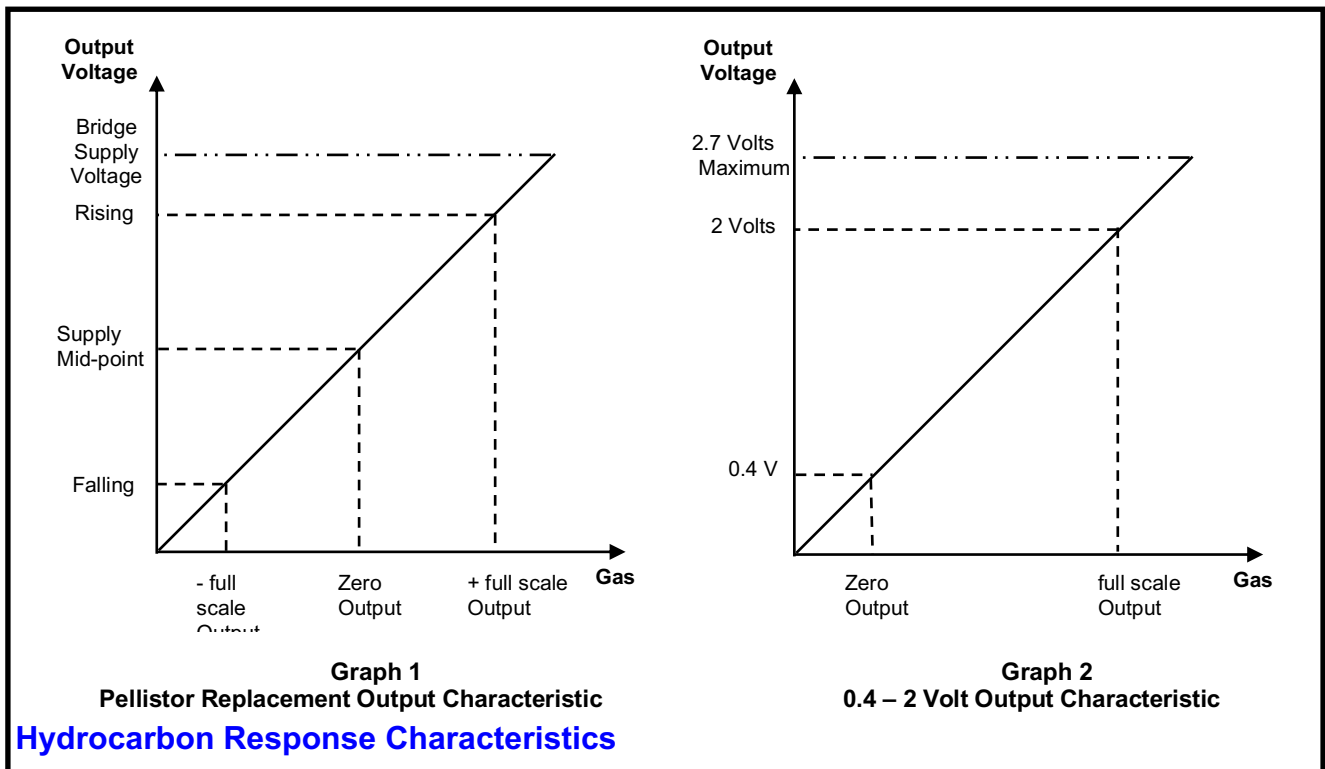

Hydrocarbon Response Characteristics

The Premier range of hydrocarbon infrared gas sensors are calibrated to provide an output signal linearised for a specific gas type and concentration during manufacture.

However, the sensor will also respond to a range of other hydrocarbon gases. The following graphs show the relative response of a methane sensor, and a propane sensor, to some of the common hydrocarbons.

These characteristics can be used as a guide to setting up the associated instrument alarm levels.

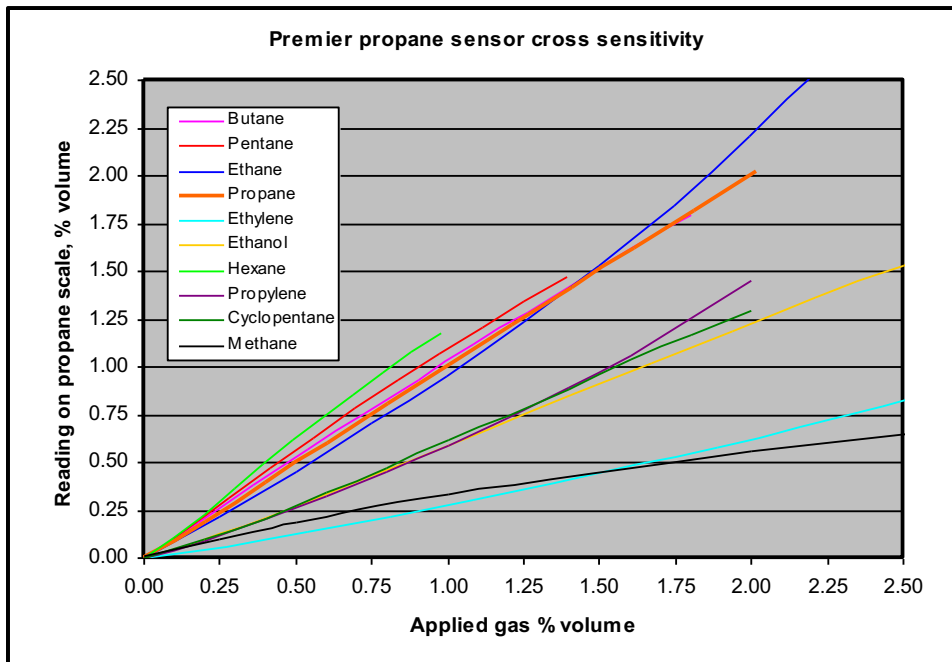
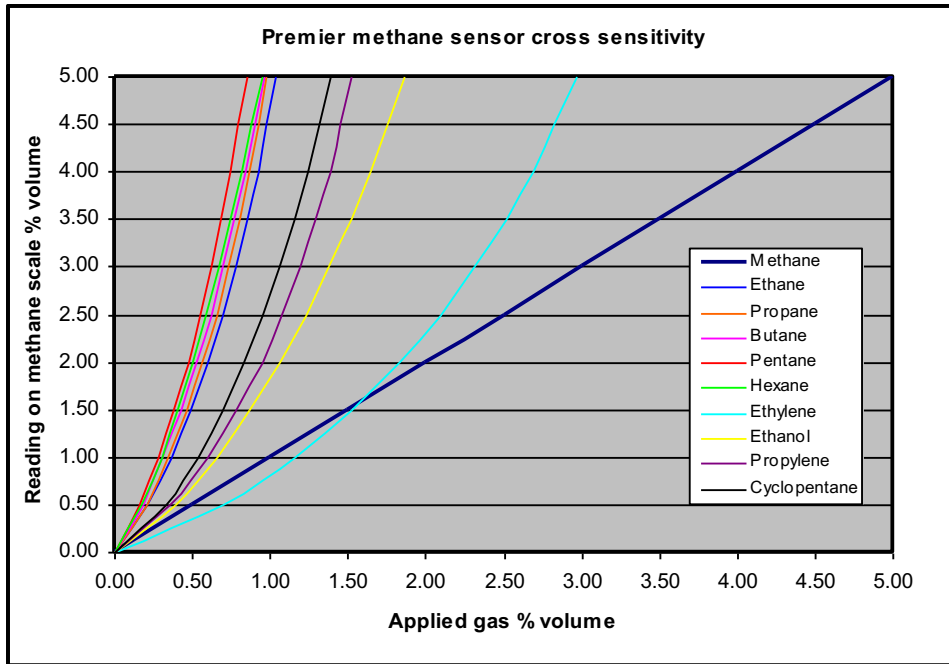

Note – Refer to data sheet tds0050 for additional cross reference data

Hydrocarbon Temperature Compensation

The Premier sensor is temperature compensated over the range of -20°C to +50°C. The output variation is $\pm 2\%$ full scale or $\pm 10\%$ of the reading up to 50% full scale and $\pm 15\%$ of the reading from 50% to 100% full scale, whichever is greater.

The following graph is based on the hydrocarbon sensor being characterised for methane.

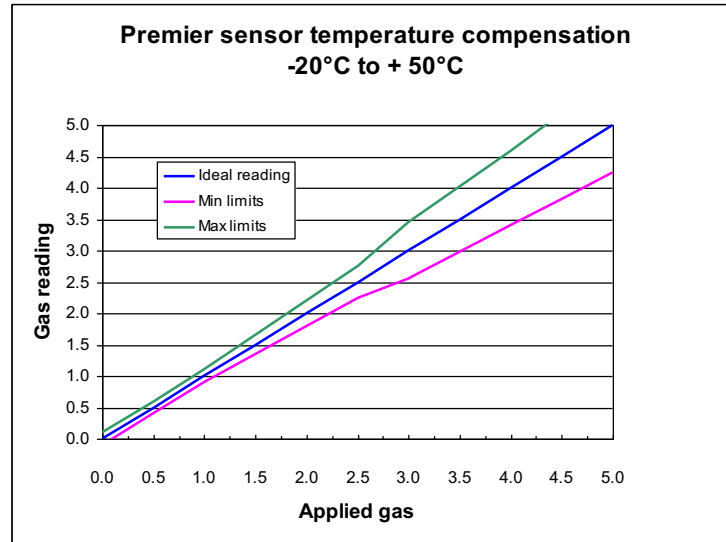

Hydrocarbon Linearity

The Premier sensor linearity at ambient temperature is $\pm 2\%$ full scale or $\pm 10\%$ of the reading whichever is greater.

The following graph is based on the hydrocarbon sensor being characterised for methane, data based on 24 sensors.

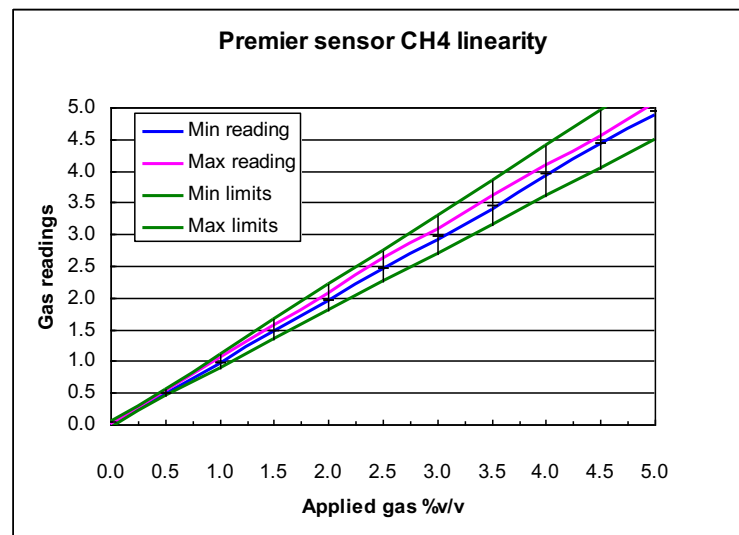

Calibration options

Dynamant recommend a maximum interval of 12 months between calibration checks. A small amount of zero drift can be accommodated by re-zeroing the gas detector against the sensor. The degree of drift that is acceptable should be determined by the user. Note that the subsequent change in gas reading will be greater than the change in zero reading. If the sensor requires either a “Zero” or “Span” adjustment, there are three methods that can be used:

- 1) By using the “Premier Configuration Unit”
When used in conjunction with dedicated PC software, this device uses the data communication pins on the sensor to provide a means of calibration. Refer to data sheet TDS0043 for additional information.
- 2) By using the data communications pins and software written in accordance with the protocol supplied by Dynamant.
- 3) By using the “Manual Calibration” feature available with firmware version 1.5.2R.
“Zero” and “Span” operations can be performed by momentarily connecting the data communication pins to the negative supply pin. Refer to data sheet TDS0064 for full instructions. The “Manual Calibration” option must be specified when the sensors are ordered.

Sensor warm-up time

When power is first applied to the sensor, the voltage at the output pin is held at a pre-determined value, by default, this is the “zero gas” value. This condition is maintained for a default “warm-up” time of 15 seconds, after this time the output voltage represents the calculated gas value. Sensors can take up to 1 minute to indicate the correct gas reading.

Note: the sensor can output any reading from -100% full scale to +200% full scale in the first minute.

The output value that is read using the communications pins is always held at zero during the “warm-up” time.

Both the voltage at the output pin during the “warm-up” time, and the duration of the “warm-up” time can be pre-programmed to alternative values at the time of ordering sensors.

Temperature transients and gas flow rates.

The Premier sensor employs a pyroelectric detector, the output from which can be disrupted by sudden changes in temperature. If there is an excessive change in the ambient temperature, gas sample temperature or flow rate, then the output signal will be momentarily frozen. Correct operation is restored when the effects of the transient have settled. Rates of change in the ambient temperature should be restricted to 2°C/minute and gas flow rates kept below 600 cc/minute.

Power supply considerations

The sensor power supply rise time must be less than 50 mS to ensure correct operation. Operation outside the range of 3 – 5 V dc will result in either fault indication, or the sensor will not function correctly.

Sensor over-range condition

The sensor will continue to provide an output up to 200% of the full scale value; at this point the reading is clamped, regardless of any further increase in detected gas level. The linearity of the output is only guaranteed up to the full scale for the sensor; the over-range condition should therefore be determined and indicated by the host instrument.

Sensor fault indication

The sensor constantly performs checks on the internal memory contents, the incoming supply voltage and the analogue signal values. These checks are used to ensure that the sensor is operating within its correct parameters, and that no internal faults have developed.

If a fault condition is detected:

- 1) the output will be set to 0V.
- 2) The output value that is read when using the communications pins, instead of the voltage output pin, will be set to -250% full-scale.

As mentioned in the “Sensor warm-up time” section above, the voltage at the output pin during the warm-up time can be specified when ordering sensors.

Digital interface

The digital communication pins “RX” and “TX” operate at a 2.8V logic level. When interfacing to external circuitry that uses a higher voltage level it is necessary to limit the current that can flow. The external voltage level should be 5V maximum and a 3K3 resistor should be used in series with each communication pin.

The Rx and Tx voltage limits are as follows:

RX - VIH: Input ‘High’ minimum voltage - $0.8 V_{DD} = 2.24V$

RX - VIL: Input ‘Low’ maximum voltage - $0.2 V_{DD} = 0.56V$

TX - VOH: Output ‘High’ minimum voltage - $V_{DD} - 0.7 = 2.1$

TX - VOL: Output ‘Low’ maximum voltage - 0.6V

Contact Dynament Ltd for details of the required protocol.

SPECIFICATION

Operating Voltage Range:	3.0 – 5.0 V d.c.
Operating Current:	Constant current operation, current range 75 – 85mA
Programmable Output Voltage Ranges:	Voltage Output Types – 0v to 2.8 volts d.c. Bridge Output Types – 0v to Bridge Supply Voltage
Methane measuring range:	0 – 5% volume up to 0 – 100% volume
Hydrocarbon measuring range	0 – 100% LEL equivalent
Resolution:	1% of measuring range for readings above 50% of range, 0.5% of measuring range for readings below 50% of range
Accuracy:	± 2% full scale @ 20°C (68°F), 1 bar pressure, applied gas 2.5% volume methane.
Warm up time:	To final zero ± 2% full scale : Approximately 1 minute @ 20°C (68°F) ambient, some sensors may take longer.
Response Time T₉₀:	<30s @ 20°C (68°F) ambient
Zero Repeatability:	± 1% full range @ 20°C (68°F) ambient
Span Repeatability:	± 2% full scale @ 20°C (68°F) ambient
Long term zero drift:	± 1% full scale per month @ 20°C (68°F) ambient, (max ± 3% full scale per year)
Operating temperature range:	-20°C to +50°C (-4°F to 122°F)
Temperature performance: <small>* May not be applicable when using gas cross-reference factors</small>	± 10% of reading up to 50% full scale, ± 15% of reading from 50% to 100% full scale, or 2% full scale whichever is greater over the range -20°C to +50°C (-4°F to 122°F)
Storage temperature range:	-20°C to +50°C (-4°F to 122°F)
Humidity range:	0 to 95% RH non-condensing.
Digital signal format:	8 data bits, 1 stop bit, no parity. 2.8V logic level
Standard baud rates:	38,400, 19,200, 9600
User configurable parameters:	Zero output voltage full scale output voltage Positive or negative going output Sensor 'zero' function Sensor 'span' function
MTBF:	> 5 years
Weight :	15 grams

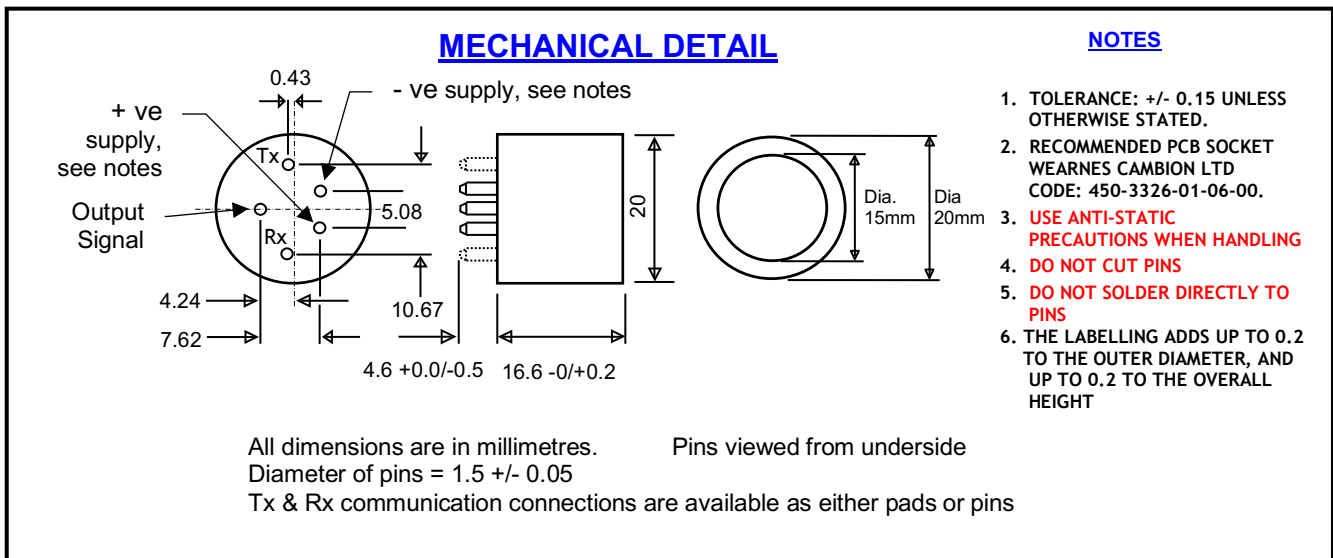

NOTE – The above pin configuration is shown for the POSITIVE version of the sensor. The NEGATIVE version has the +ve and –ve supply pin positions exchanged. See ordering details.

Ordering Details

In order to completely specify the type of sensor that is required, the customer needs to provide the following information:-

- An Order Code (see below) that specifies the sensors' basic physical and electrical characteristics.
- The sensor configuration requirements.

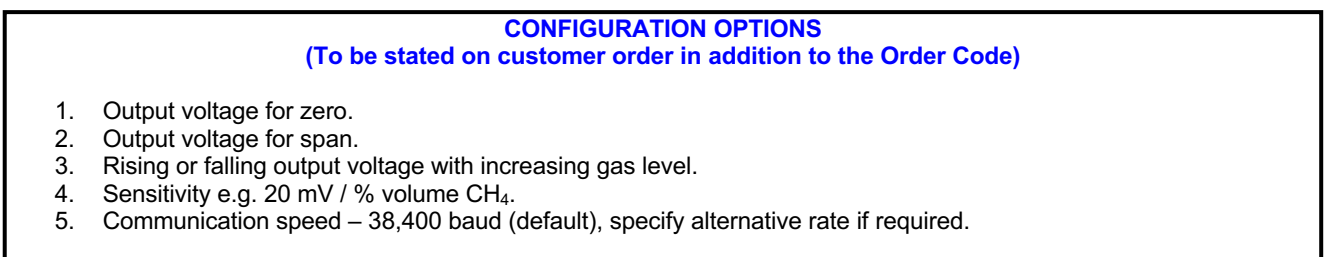
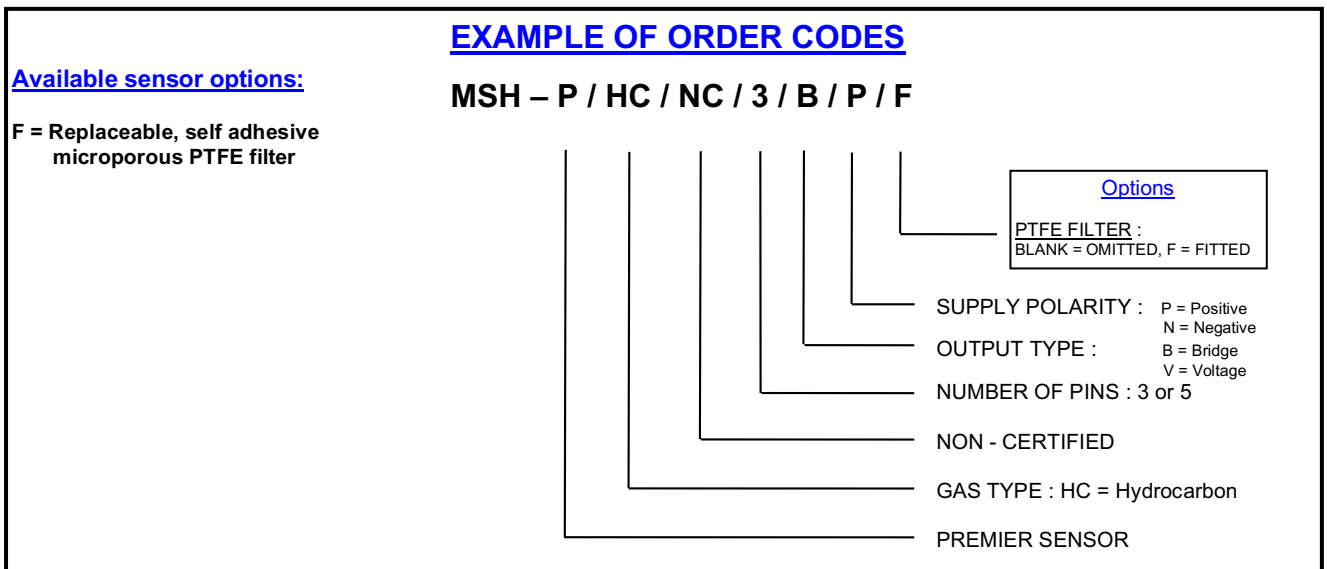

Pellistor Replacement - Explanation of Positive & Negative Polarity

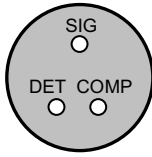

Typical Pellistor Pinout

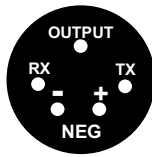

Premier Negative Polarity Option

Use where the DET pin of the existing pellistor is connected to the Negative of the pellistor bridge supply.

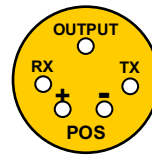

Premier Positive Polarity Option

Use where DET pin of the existing pellistor is connected to the Positive of the pellistor bridge supply.

Note – On the 3 pin version of the sensor, the RX and TX connections are pads, not pins.

Warranty information

All Dynament Premier sensors carry a five year warranty against defects in materials and workmanship. The warranty is invalidated if the sensors are used under conditions other than those specified in this data sheet.

Particular attention should be paid to the following criteria:

- **Observe the correct supply polarity**
- **Do not exceed the maximum rated supply voltage of 5V**
- **Do not solder directly to the sensor pins**
- **Do not expose the sensor to corrosive gases such as hydrogen sulphide**
- **Do not allow condensation to take place within the sensor**

Dynament reserve the right to alter technical specifications, without prior notice, when it is appropriate to implement a technical enhancement that leads to improved performance. Should any changes be required that could affect the customer's use of the product, Dynament will endeavour to contact customers directly to inform them of the changes.