

ACCESSORIES FOR USE WITH THE DYNAMENT RANGE OF INFRARED GAS SENSORS

SENSOR MOUNTING (Part No. OEM-1-MTG)

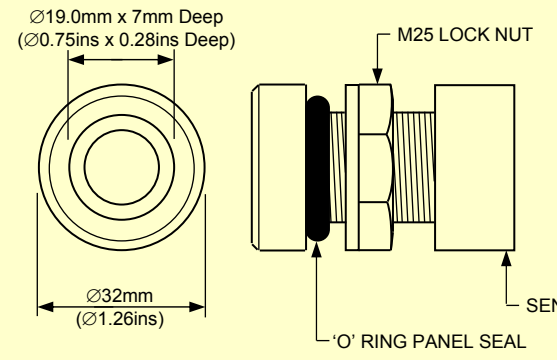

- ◆ Provides a rapid means of mounting sensor into equipment.
- ◆ Maximum panel thickness 4.5mm (0.18ins).
- ◆ Manufactured from grey PVC.
- ◆ Fitted with internal foam gasket seal.

GAS SAMPLING ADAPTOR (Part No. OEM-1-ADTR)

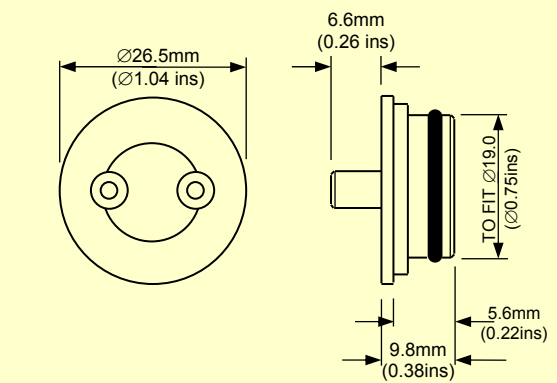

- ◆ Sampling Adaptor for use with above sensor mounting.
- ◆ Accepts flexible, push fit tubing.
- ◆ Supplied with two blanking caps for zero gas calibrations.

Blanking Cap

SENSOR CABLE & CONNECTOR (Part No. OEM-1-CABLE)

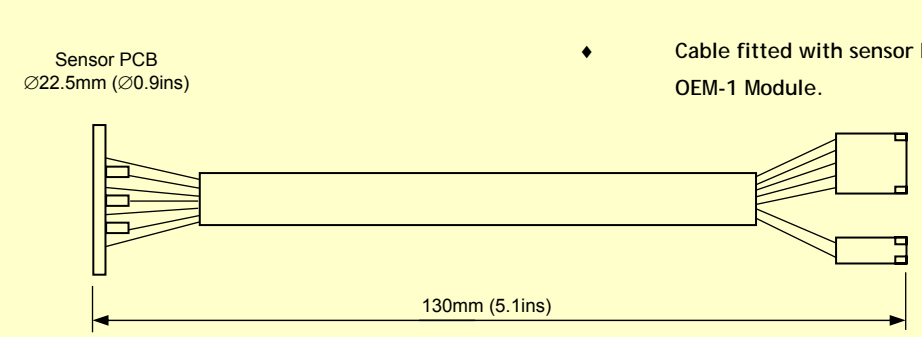

- ◆ Cable fitted with sensor PCB & connectors for use with OEM-1 Module.

DYNAMENT OEM COMMUNICATIONS SOFTWARE (Part No. OEM-1-SOFTWARE)

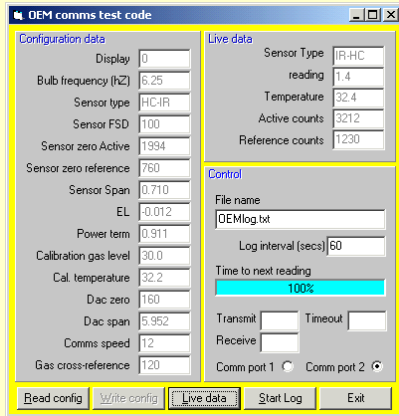

- ◆ Software development tool to gather and process data via the RS232 port of the OEM Module.
- ◆ Allows the user to modify the operation of the module
- ◆ Enables reprogramming of the module via a PC
- ◆ Provides a tabular display of sensor parameters
- ◆ Data logging facility to record sensor outputs automatically during test procedures
- ◆ Allows the application of temperature compensation factors

RS232 CONNECTION LEAD (Part No. OEM-1-LEAD)

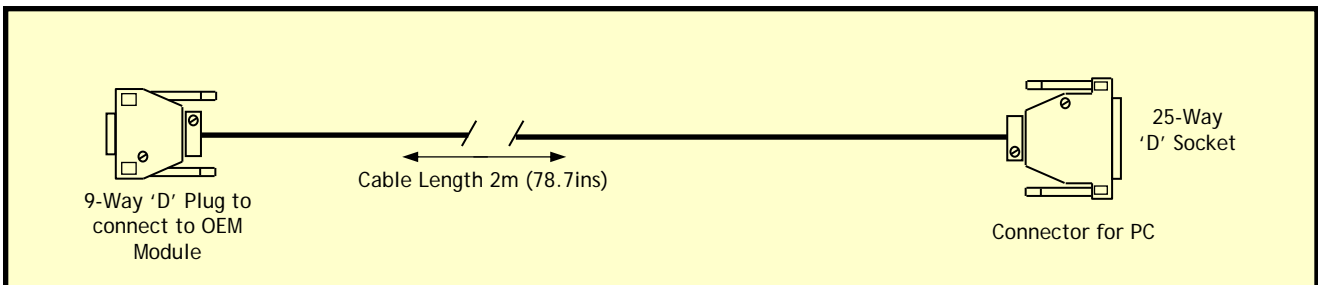

PREMIER SENSOR CIRCUIT BOARD WITH LEADS (Part No. P/PCB)

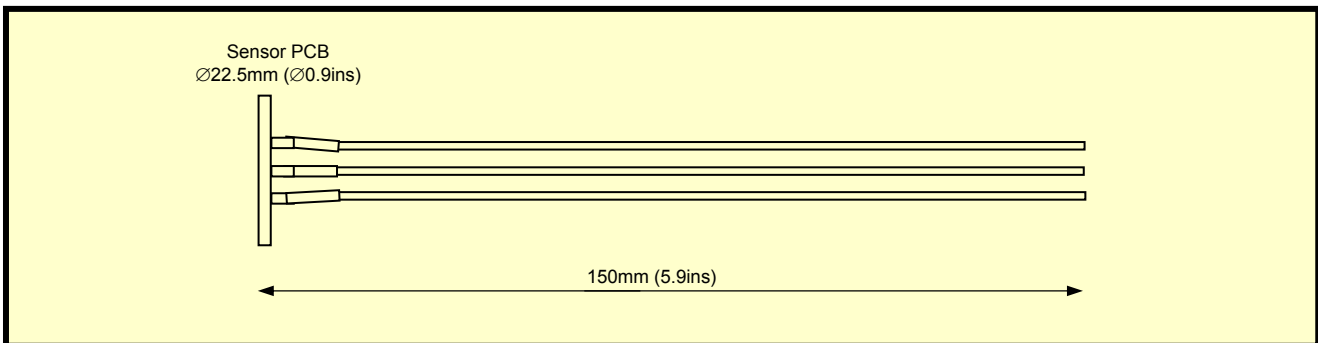

PREMIER SENSOR CIRCUIT BOARD WITHOUT LEADS (Part No. P/PCB/NL)

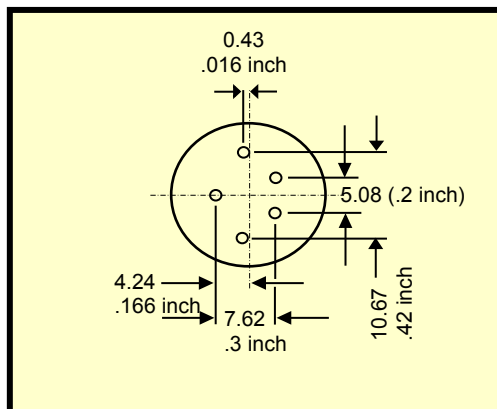

PCB SOCKET FOR ALL SENSOR TYPES (Part No SENSOR SOCKET)

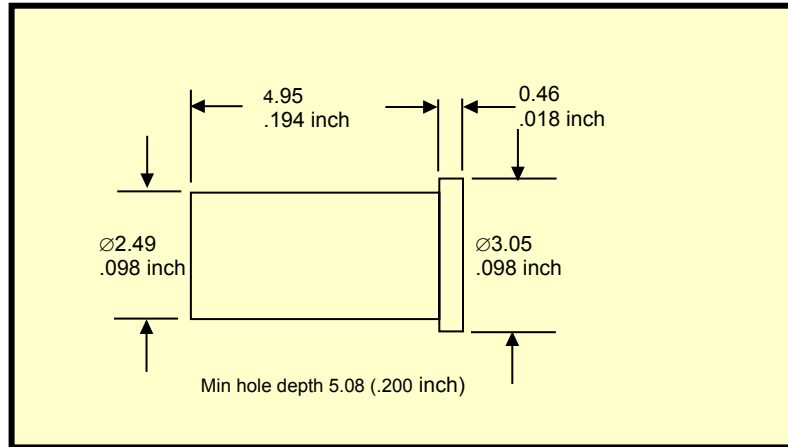

ORDERING INFORMATION

ITEM	DYNAMENT PART NUMBER
SENSOR MOUNTING	OEM – 1- MTG
GAS SAMPLING ADAPTOR	OEM – 1- ADTR
SENSOR CABLE AND CONNECTOR	OEM – 1-CABLE (130mm, 5.1”)
DYNAMENT OEM COMMUNICATIONS SOFTWARE	OEM – 1 - SOFTWARE
RS232 CONNECTION LEAD	OEM – 1 - LEAD
PREMIER SENSOR CIRCUIT BOARD WITH LEADS	P/PCB
PREMIER SENSOR CIRCUIT BOARD WITHOUT LEADS	P/PCB/NL
PCB SOCKET FOR ALL SENSOR TYPES	SENSOR SOCKET
1 MICRON SELF-ADHESIVE FILTER FOR ALL SENSOR TYPES	FILTER (PTFE)

Dynament Limited

Hermitage Lane Industrial Estate · Kings Mill Way · Mansfield · Nottinghamshire · NG18 5ER · UK.

Tel: 44 (0)1623 663636 · Fax: 44 (0)1623 421063

email: sales@dynament.com · www.dynament.com